

TRITON[®]

Catalog **2023**



CLOAKROOM
EQUIPMENT



www.shop.satniskrinky.cz
www.clotheslockers.eu

Content

About Company	4
Modular	8
Combined clothes lockers.....	12
Laminated clothes lockers	20
Steel clothes lockers	24
Golf lockers	32
Saddle locker	36
Ball locker	38
Hockey box and multipurpose boxes	40
Ski and snowboard lockers	46
Fire lockers and lockers for rescue services	50
Key lockers	58
Cloakroom seats	60
Whole laminated wardrobe bench	62
Design self-watering flowerpot	63
Shelf racks	64
Workbenches	66
Container	68
Additional steel production and cooperation	69
Multifunctional storage wall	72
Mail box	74
Stand for Disinfectant Dispenser.....	75
Hygienestand	76
Accessories	78
Locks.....	80
Project realization	87
Offer decors	88
References	96
Marketing – Exhibitions	104
Presentation	106
Packaging, transportation	107
Notes	108
Certificates	111



About us

Triton Pardubice, spol. s r. o. with almost 30 years of tradition, is one of the world's leading manufacturers of 19" information, telecommunications and power cabinets, and accessories for them.

The production and development center with a total production area of 17,000 m² and more than 190 employees and specialists is located in Stary Mateřov, 5 km from Pardubice. Here, production is constantly modernized. In January 2022, the fifth production shop was completed and put into operation, inclu-

ding a new control room and carpentry shop with added process equipment.

Triton company also develops and manufactures products used to equip dressing rooms, workshops and offices. For example, lockers, boxes, hanging walls, hockey boxes, workshop furniture, or special cabinets for firefighters or sports equipment (balls, skis, snowboards, bridles, golf). Interior whole laminated benches is a recently added product. All products are available in new decor lines, in line with the latest design trends.



7. 12. In 2021, a new hall with a usable area of almost 3,000 m² was approved.



Automated bending center



Automated bending center



Automated bending center



Automated punch machine



Center for glass gluing and cabinet door seal applications



Cross-cut saw KP 500 Automat



Nesting machining center



Dowel insertion machine



Edgebander tempora F800



Automatic milling center with feeder

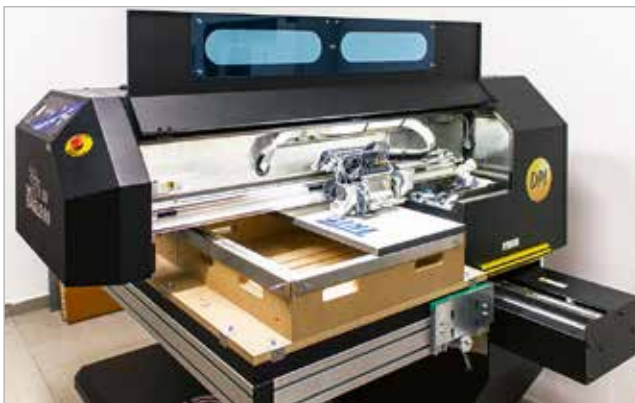

UV LED printer



Stacking machine for the production of pallets



Modular

Triton Modular clothes lockers introduce a brand new and variable concept. The body is made of steel and can be adjusted to the customers' needs; whether they need a 2-door locker, 4-box, 6-box, 8-box, or other combinations.

Doors can be made of steel or laminated chipboard and can be oriented as left, right, or left/right. Quality Hettich hinges are used to attach them to the frame.

Doors are ready for cylindrical locks or turning locks BURG as standard. Shelves have integrated holders for clothes rods.

Sizes are 1970 x 600 x 500 mm, or 1970 x 800 x 500 mm (h x w x d).

All lockers are made of high quality steel and are delivered assembled.



Furniture hinges Hettich



Shelves with chromed clothes rod detail



Levelling feet



Modular lockers Triton can be customized to the most demanded options - all this with the use of just one frame. The body and dividing wall are perforated for different door, shelf and lock positions.

This versatility not only makes the delivery faster but also gives the customers the possibility to change the locker later, e.g. in case the customer needs to expand the locker room.

Steel parts are powder coated. Laminated chipboard doors are protected by 2 mm ABS edging.



COLOR						
	steel grey (RAL 7035)	steel blue (RAL 5005)	steel black (RAL 9005)	white laminate	antracit laminte	
EGGER	Kronospan STANDARD					
		Maple Mandal	Birch 1715 BS	Nagano Oak 8431 SN	Cherry 0344 BS	Walnut 0729 BS
Kronospan CONTEMPO						
	Concrete Flow K350 RT	Light Rockford Hickory K085 PW	Blonde Surfside Ash K525 SN	Gold Baroque Oak K535 RW	Amber Baroque Oak K536 RW	

An extended range of decors can be found on page 88.



2-door		
Height x width x depth (mm)	1970 x 600 x 500	1970 x 800 x 500
Number of sections	2	2
Equipment	2 x shelf, 2 x rod	2 x shelf, 2 x rod
Weight net / gross (kg)	60 / 64	70 / 75
Order code	IVD-20-X65-XXX-X1	IVD-20-X85-XXX-X1



4-box		
Height x width x depth (mm)	1970 x 600 x 500	1970 x 800 x 500
Number of sections	4	4
Equipment	4 x rod	4 x rod
Weight net / gross (kg)	59 / 63	69 / 74
Order code	IVC-20-X65-XXX-X1	IVC-20-X85-XXX-X1

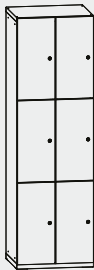

6-box		
Height x width x depth (mm)	1970 x 600 x 500	1970 x 800 x 500
Number of sections	6	6
Weight net / gross (kg)	60 / 65	71 / 76
Order code	IVE-20-X65-XXX-X1	IVE-20-X85-XXX-X1

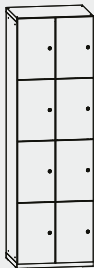

8-box		
Height x width x depth (mm)	1970 x 600 x 500	1970 x 800 x 500
Number of sections	8	8
Weight net / gross (kg)	63 / 68	74 / 79
Order code	IVF-20-X65-XXX-X1	IVF-20-X85-XXX-X1



Neubau Klinikum Fulda

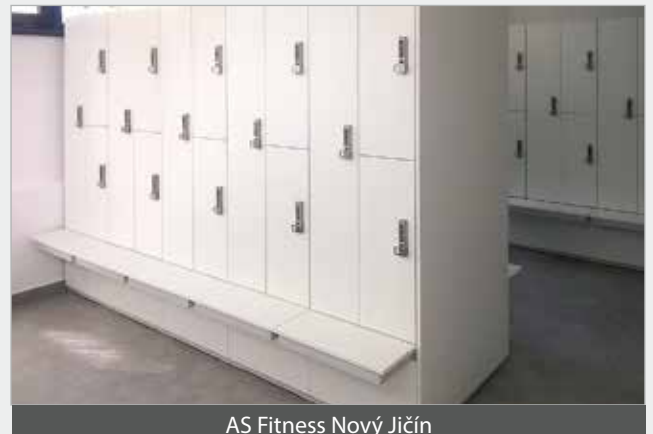

AS Fitness Nový Jičín



I'M FIT Liberec



Combined clothes lockers

Steel and laminated chipboard combination

Combined clothes lockers have bodies made of quality steel with powder coated finish and laminate chipboard with various decors. Lockers have pre-made holes if any shelves should be added.

Perforation in the steel frame ensures effective ventilation. Lockers can be screwed together to create one compact unit.

Lockers made of steel and laminated chipboard offer reliable and high quality equipment for locker rooms in companies, schools, sport facilities, hospitals, etc.

The basic color of steel corpus consists of a shade RAL 7035 and RAL 9005.

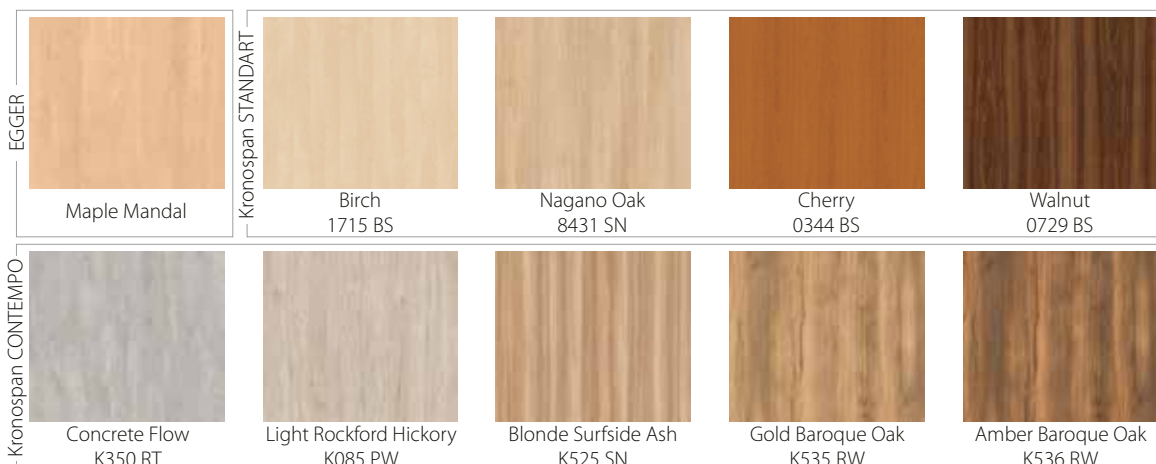

An extended range of decors can be found on page 88.



Solid frame construction



Air system



Chrome bar



Unique hinges
(180° door opening)



Practical shelves



Levelling feet



1-door			
Height x width x depth (mm)	1525 x 420 x 500	1750 x 420 x 500	1970 x 420 x 500
Number of sections	1	1	1
Equipment	1 x shelf, 1 x rod	1 x shelf, 1 x rod	2 x shelf, 1 x rod
Weight net / gross (kg)	31 / 38	35 / 42	39 / 45
Order code	ISS-15-B45-XXX-X2	ISS-18-B45-XXX-X2	ISS-20-B45-XXX-X2



1-door with a seat		
Height x width x depth (mm)	1970 x 420 x 780	2195 x 420 x 780
Number of sections	1	1
Equipment	1 x shelf, 1 x rod	1 x shelf, 1 x rod
Weight net / gross (kg)	39 / 47	43 / 51
Order code	ISS-20-B48-XXX-A2	ISS-22-B48-XXX-A2



2-door			
Height x width x depth (mm)	1525 x 600 x 500	1750 x 600 x 500	1970 x 600 x 500
Number of sections	2	2	2
Equipment	2 x shelf, 2 x rod	2 x shelf, 2 x rod	4 x shelf, 2 x rod
Weight net / gross (kg)	48 / 54	54 / 60	62 / 69
Order code	ISD-15-B65-XXX-X2	ISD-18-B65-XXX-X2	ISD-20-B65-XXX-X2

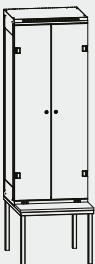

2-door with a seat		
Height x width x depth (mm)	1970 x 600 x 780	2195 x 600 x 780
Number of sections	2	2
Equipment	2 x shelf, 2 x rod	2 x shelf, 2 x rod
Weight net / gross (kg)	57 / 65	63 / 71
Order code	ISD-20-B68-XXX-A2	ISD-22-B68-XXX-A2

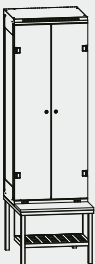

2-door with a seat with integrated grate		
Height x width x depth (mm)	1970 x 600 x 780	2195 x 600 x 780
Number of sections	2	2
Equipment	2 x shelf, 2 x rod	2 x shelf, 2 x rod
Weight net / gross (kg)	61 / 69	67 / 75
Order code	ISD-20-B68-XXX-R2	ISD-22-B68-XXX-R2

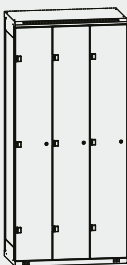

3-door		
Height x width x depth (mm)	1750 x 900 x 500	1970 x 900 x 500
Number of sections	3	3
Equipment	3 x shelf, 3 x rod	6 x shelf, 3 x rod
Weight net / gross (kg)	74 / 80	86 / 91
Order code	IST-18-B95-XXX-X2	IST-20-B95-XXX-X2



2-door locker, grey RAL 7035/cherry-tree locarno laminate



3-door locker, grey RAL 7035/maple mandal laminate



2-door locker, grey RAL 7035/maple mandal



2-door locker with a bench, grey RAL 7035/pine laminate



2-door locker with a bench, grey RAL 7035/cherry-tree locarno laminate

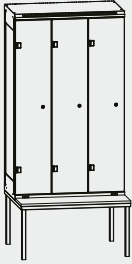

3-door with a seat		
Height x width x depth (mm)	1970 x 900 x 780	2195 x 900 x 780
Number of sections	3	3
Equipment	3 x shelf, 3 x rod	3 x shelf, 3 x rod
Weight net / gross (kg)	77 / 85	85 / 90
Order code	IST-20-B98-XXX-A2	IST-22-B98-XXX-A2

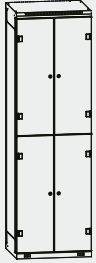

4-box			
Height x width x depth (mm)	1525 x 600 x 500	1750 x 600 x 500	1970 x 600 x 500
Number of sections	4	4	4
Equipment	4 x rod	4 x rod	4 x rod
Weight net / gross (kg)	49 / 57	54 / 60	59 / 66
Order code	ISC-15-B65-XXX-X2	ISC-18-B65-XXX-X2	ISC-20-B65-XXX-X2

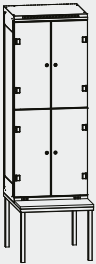

4-box with a seat		
Height x width x depth (mm)	1970 x 600 x 780	2195 x 600 x 780
Number of sections	4	4
Equipment	4 x rod	4 x rod
Weight net / gross (kg)	58 / 66	67 / 75
Order code	ISC-20-B68-XXX-A2	ISC-22-B68-XXX-A2

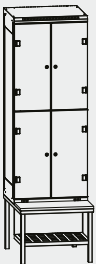

4-box with a seat with integrated grate		
Height x width x depth (mm)	1970 x 600 x 780	2195 x 600 x 780
Number of sections	4	4
Equipment	4 x rod	4 x rod
Weight net / gross (kg)	62 / 70	71 / 79
Order code	ISC-20-B68-XXX-R2	ISC-22-B68-XXX-R2

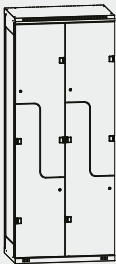

„Z“-type	
Height x width x depth (mm)	1970 x 800 x 500
Number of sections	4
Equipment	4 x rod
Weight net / gross (kg)	69 / 77
Order code	ISZ-20-B85-XXX-X2

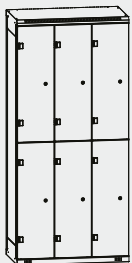

6-box	
Height x width x depth (mm)	1970 x 900 x 500
Number of sections	6
Equipment	6 x rod
Weight net / gross (kg)	78 / 88
Order code	ISE-20-B95-XXX-X2

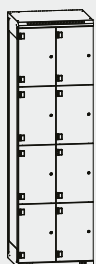

8-box	
Height x width x depth (mm)	1970 x 600 x 500
Number of sections	8
Equipment	-
Weight net / gross (kg)	59 / 66
Order code	ISF-20-B65-XXX-X2



4-box locker,
grey RAL 7035/maple mandal
laminat



4-box locker,
grey RAL 7035/oak bardolino laminate



4-box locker with a bench,
black RAL 9005/oak corbridge laminate



4-box „Z“ locker,
grey RAL 7035/maple mandal laminate



6-box locker,
black RAL 9005/oak bardolino laminate



8-box locker,
black RAL 9005/maple mandal laminate



Amusement park Krokodýlek, Olomouc



Nordic Lockers



Golf Club Pyšely



Sauna paradise Holic



Golf resort Malacky Eurovalley Golf Park



Elementary school Schulzovy sady



Fitness Sokolov



Laminated clothes lockers

Laminate clothes lockers are made from laminated chipboard with a thickness of 18mm in timeless decors. Simple and elegant design is complemented by cylindrical lock with two keys or any other locking solution. All edges are finished with 2mm ABS.

Stainless steel perforated grille allows circulation of the air together with offset doors.

Unique hinges Hettich Intermat ensure quite closing of the doors.

This locker will become an elegant part of your interior.



EGGER		Kronospan STANDART				
	Maple Mandal		Birch 1715 BS	Nagano Oak 8431 SN	Cherry 0344 BS	Walnut 0729 BS
Kronospan CONTEMPO						
	Concrete Flow K350 RT	Light Rockford Hickory K085 PW	Blonde Surfside Ash K525 SN	Gold Baroque Oak K535 RW	Amber Baroque Oak K536 RW	

An extended range of decors can be found on page 88.





1-door	
Height x width x depth (mm)	1970 x 420 x 500
Number of sections	1
Equipment	2 x shelf, 1 x rod
Weight net / gross (kg)	39 / 45
Order code	ILS-20-B45-XXX-XN



2-door	
Height x width x depth (mm)	1970 x 600 x 500
Number of sections	2
Equipment	4 x shelf, 2 x rod
Weight net / gross (kg)	62 / 69
Order code	ILD-20-B65-XXX-XN



2-door with a seat	
Height x width x depth (mm)	1970 x 600 x 780
Number of sections	2
Equipment	2 x shelf, 2 x rod
Weight net / gross (kg)	57 / 65
Order code	ILD-20-B65-XXX-AN

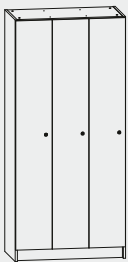

3-door	
Height x width x depth (mm)	1970 x 900 x 500
Number of sections	3
Equipment	6 x shelf, 3 x rod
Weight net / gross (kg)	86 / 91
Order code	ILT-20-B95-XXX-XN

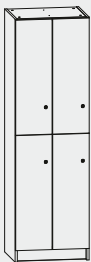

4-box	
Height x width x depth (mm)	1970 x 600 x 500
Number of sections	4
Equipment	4 x shelf, 4 x rod
Weight net / gross (kg)	59 / 66
Order code	ILC-20-B65-XXX-XN

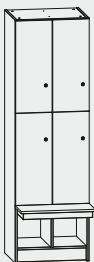

4-box with a seat	
Height x width x depth (mm)	1970 x 600 x 780
Number of sections	4
Equipment	4 x rod
Weight net / gross (kg)	58 / 66
Order code	ILC-20-B68-XXX-AN

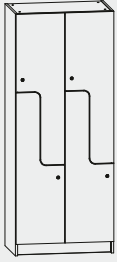

„Z“ box	
Height x width x depth (mm)	1970 x 800 x 500
Number of sections	4
Equipment	4 x rod
Weight net / gross (kg)	69 / 77
Order code	ILZ-20-B85-XXX-XN

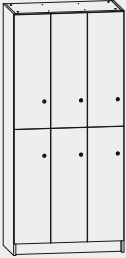

6-box	
Height x width x depth (mm)	1970 x 900 x 500
Number of sections	6
Equipment	6 x shelf, 6 x rod
Weight net / gross (kg)	78 / 88
Order code	ILE-20-B95-XXX-XN

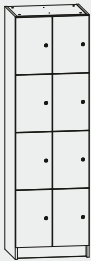

8-box	
Height x width x depth (mm)	1970 x 600 x 500
Number of sections	8
Equipment	-
Weight net / gross (kg)	59 / 66
Order code	ILF-20-B65-XXX-XN

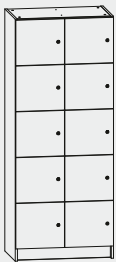

10-box	
Height x width x depth (mm)	1970 x 800 x 500
Number of sections	8
Equipment	-
Weight net / gross (kg)	59 / 66
Order code	ILG-20-B85-XXX-XN





Steel clothes lockers

Steel clothes lockers are made of quality steel with powder-coated finish. Powder-coating technology fully meets our customers' requirements. The paint is very resistant against chemical or mechanical damage.

A rigid frame ensures stability of every locker. Reinforced doors can be opened almost up to 180° due to our unique hinges. Perforations in doors and frame ensure effective air-ventilation.

Levelling feet are always included.

Lockers can be screwed together to create one compact unit.

Timeless design and high quality are the main features of Tritón lockers. They can be used in locker rooms of schools, sport facilities, hospitals, etc.

Standard colour range is RAL 7035 (light grey), RAL 5005 (blue), and RAL 9005 (black).

Other colours from RAL sampler are available upon request.

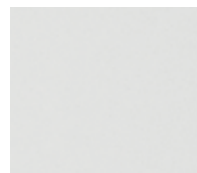

steel grey
(RAL 7035)



steel blue
(RAL 5005)

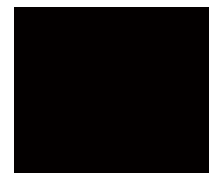

steel black
(RAL 9005)



Solid frame construction



Air circulation system



Solid section divider



Reinforced door frame,
unique hinges



Practical shelves



Levelling feet

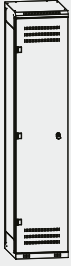

1-door			
Height x width x depth (mm)	1525 x 420 x 500	1750 x 420 x 500	1970 x 420 x 500
Number of sections	1	1	1
Equipment	1 x shelf, 1 x rod	1 x shelf, 1 x rod	2 x shelf, 1 x rod
Weight net / gross (kg)	29 / 35	32 / 39	36 / 43
Order code	ISS-15-A45-XXX-X2	ISS-18-A45-XXX-X2	ISS-20-A45-XXX-X2

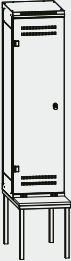

1-door with a seat		
Height x width x depth (mm)	1970 x 420 x 780	2195 x 420 x 780
Number of sections	1	1
Equipment	1 x shelf, 1 x rod	1 x shelf, 1 x rod
Weight net / gross (kg)	37 / 45	40 / 48
Order code	ISS-20-A48-XXX-A2	ISS-22-A48-XXX-A2



2-door			
Height x width x depth (mm)	1525 x 600 x 500	1750 x 600 x 500	1970 x 600 x 500
Number of sections	2	2	2
Equipment	2 x shelf, 2 x rod	2 x shelf, 2 x rod	4 x shelf, 2 x rod
Weight net / gross (kg)	44 / 51	50 / 57	57 / 63
Order code	ISD-15-A65-XXX-X2	ISD-18-A65-XXX-X2	ISD-20-A65-XXX-X2



2-door with a seat		
Height x width x depth (mm)	1970 x 600 x 780	2195 x 600 x 780
Number of sections	2	2
Equipment	2 x shelf, 2 x rod	2 x shelf, 2 x rod
Weight net / gross (kg)	54 / 62	58 / 66
Order code	ISD-20-A68-XXX-A2	ISD-22-A68-XXX-A2

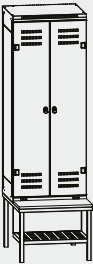

2-door with a seat with integrated grate		
Height x width x depth (mm)	1970 x 600 x 780	2195 x 600 x 780
Number of sections	2	2
Equipment	2 x shelf, 2 x rod	2 x shelf, 2 x rod
Weight net / gross (kg)	58 / 66	62 / 70
Order code	ISD-20-A68-XXX-R2	ISD-22-A68-XXX-R2



3-door		
Height x width x depth (mm)	1750 x 900 x 500	1970 x 900 x 500
Number of sections	3	3
Equipment	3 x shelf, 3 x rod	6 x shelf, 3 x rod
Weight net / gross (kg)	67 / 77	76 / 86
Order code	IST-18-A95-XXX-X2	IST-20-A95-XXX-X2



2-door locker, grey RAL 7035/blue RAL 5005



2-door locker with a bench, grey RAL 7035



1-door locker,
grey RAL 7035/blue RAL 5005



3-door locker,
grey RAL 7035/blue RAL 5005



3-door locker with a bench,
grey RAL 7035/black RAL 9005

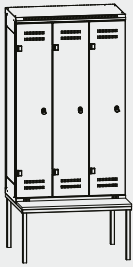

3-door with a seat		
Height x width x depth (mm)	1970 x 900 x 780	2195 x 900 x 780
Number of sections	3	3
Equipment	3 x shelf, 3 x rod	3 x shelf, 3 x rod
Weight net / gross (kg)	72 / 79	79 / 84
Order code	IST-20-A98-XXX-A2	IST-22-A98-XXX-A2



4-box			
Height x width x depth (mm)	1525 x 600 x 500	1750 x 600 x 500	1970 x 600 x 500
Number of sections	4	4	4
Equipment	4 x rod	4 x rod	4 x rod
Weight net / gross (kg)	48 / 55	52 / 58	57 / 63
Order code	ISC-15-A65-XXX-X2	ISC-18-A65-XXX-X2	ISC-20-A65-XXX-X2



4-box with a seat		
Height x width x depth (mm)	1970 x 600 x 780	2195 x 600 x 780
Number of sections	4	4
Equipment	4 x rod	4 x rod
Weight net / gross (kg)	58 / 64	61 / 69
Order code	ISC-20-A68-XXX-A2	ISC-22-A68-XXX-A2



4-box with a seat with integrated grate		
Height x width x depth (mm)	1970 x 600 x 780	2195 x 600 x 780
Number of sections	4	4
Equipment	4 x rod	4 x rod
Weight net / gross (kg)	62 / 68	65 / 73
Order code	ISC-20-A68-XXX-R2	ISC-22-A68-XXX-R2

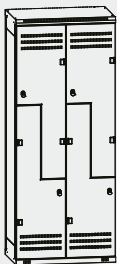

„Z“-type	
Height x width x depth (mm)	1970 x 800 x 500
Number of sections	4
Equipment	4 x rod
Weight net / gross (kg)	64 / 74
Order code	ISZ-20-A85-XXX-X2



6-boxové	
Height x width x depth (mm)	1970 x 900 x 500
Number of sections	6
Equipment	6 x rod
Weight net / gross (kg)	73 / 83
Order code	ISE-20-A95-XXX-X2



8-box	
Height x width x depth (mm)	1970 x 600 x 500
Number of sections	8
Equipment	-
Weight net / gross (kg)	54 / 61
Order code	ISF-20-A65-XXX-X2

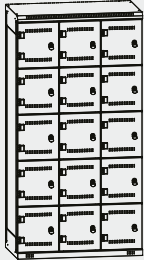

15-box	
Height x width x depth (mm)	1750 x 900 x 500
Number of sections	15
Equipment	-
Weight net / gross (kg)	94 / 104
Order code	ISO-18-A95-XXX-X2



4-box locker with a bench, grey RAL 7035/blue RAL 5005



15-box locker, grey RAL 7035/grey RAL 7035 and blue RAL 5005



Tritón Pardubice, spol. s r.o.



Tritón Pardubice, spol. s r.o.



Elementary School Pardubice – Polabiny, Npor. Eliáše



Agrarlandtechnik



Euro Bus



Neu Mitte Schule



AZ Herentals



Internationale Schule Hamburg



Vodovody a kanalizace Přebouč



Hotel Melia Wien



Dostihový spolek Pardubice



Elementary School and Kindergarten Chotíkov



APAG Elektronik s.r.o.



Golf lockers

Golf lockers are designed for safe storage of golf bags, carts, and other equipment. A shelf for power distribution unit or a cart charger is located on the locker's side. A hole in the rear ensures easy wiring into the locker. Users will certainly appreciate the small box on the reinforced door for golf balls or other small items.

Perforation in the door and in the body serves for air-ventilation. Stored items are safely locked with high quality locks. Triton golf lockers can be placed in two levels.



Power distribution unit shelf



Opening for electric

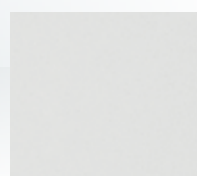

steel grey
(RAL 7035)



steel blue
(RAL 5005)



steel black
(RAL 9005)



Golf lockers – steel			
Height x width x depth (mm)	1250 x 550 x 550	1250 x 825 x 550	1250 x 825 x 1100
Equipment	basket for golf balls and small items, shelf for a power distribution unit		
Weight net / gross (kg)	36 / 43	44 / 50	62 / 69
Order code	IGS-13-A55-XXX-XX	IGS-13-A85-XXX-XX	IGS-13-A80-XXX-XX

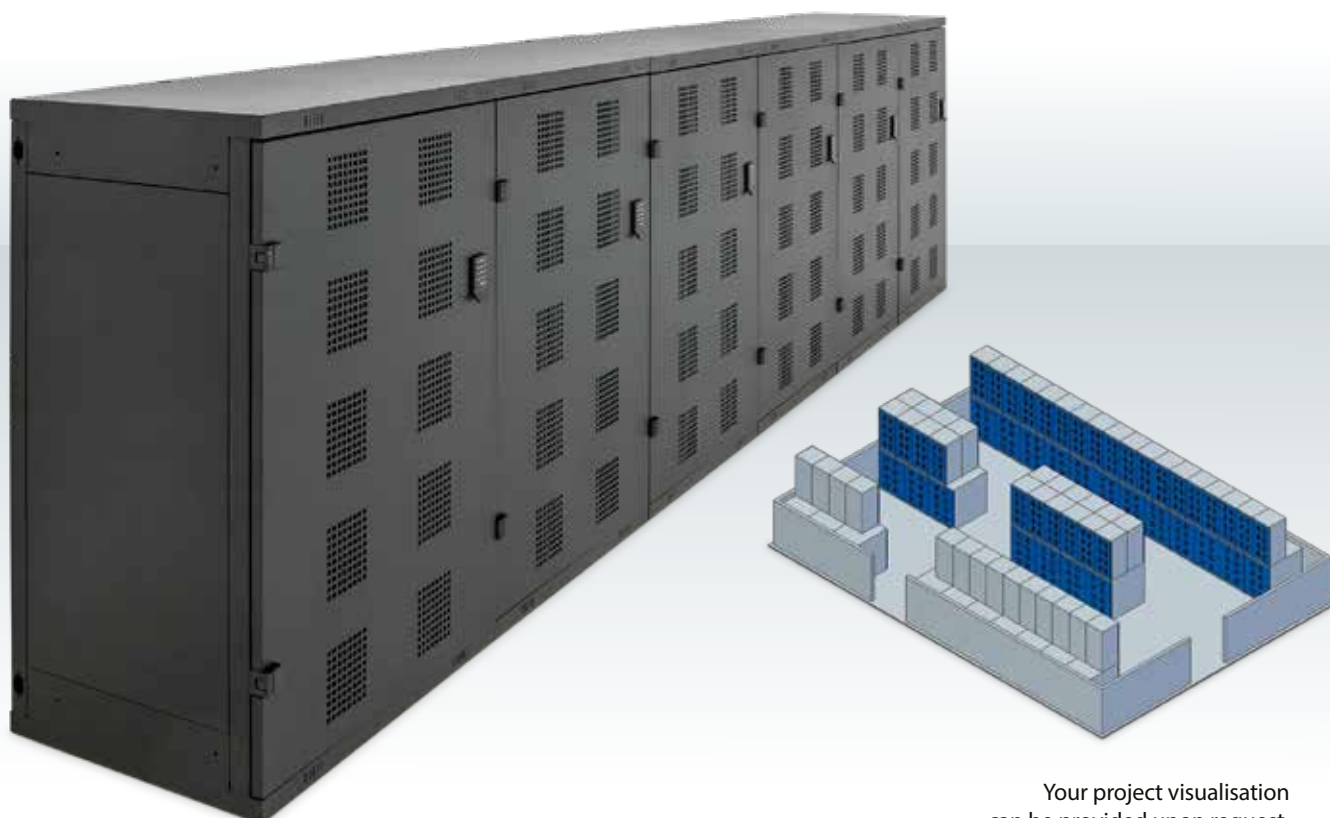

Your project visualisation can be provided upon request.



Migros Golfplatz Moossee



Golf Club Pardubice - Lázně Bohdaneč



Golf Club Pyšely



Golf resort Buchholz



City & Country Golfclub Am Wienerberg



Les Bois



Golfplatz Clebronn



Golf Club Bad Rappenau



Golf-Club Peine-Edemissen e.V.



Golf Mstětice



Golf Club Gams Werdenberg





Saddle locker

Saddle lockers are designed to store saddles and other equestrian equipment. Lockers are made of high quality zinc-coated steel with powder-coated finish. This combination ensures resistance to chemical or mechanical damage. Lockers can be screwed together to create one compact unit.

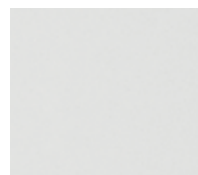

steel grey
(RAL 7035)



steel blue
(RAL 5005)

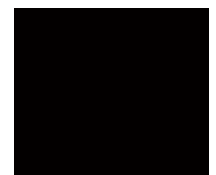

steel black
(RAL 9005)

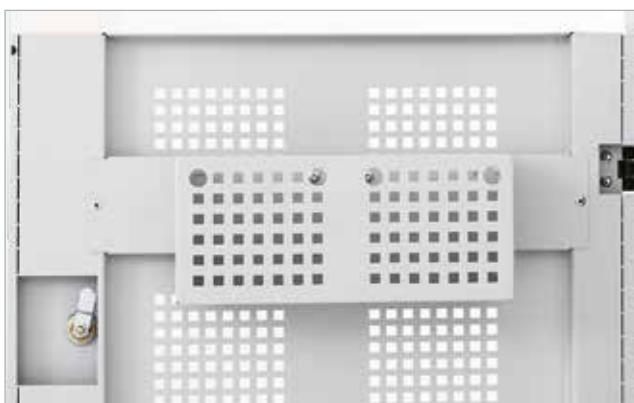



Saddle locker

Height x width x depth (mm)	1100 x 600 x 600
Number of sections	1
Equipment	2 x saddle holder including a hook for a bridle, 2 x steel hanger for bridles, basket for small items
Weight net / gross (kg)	42 / 47
Order code	KSS-11-A66-XXX-X1













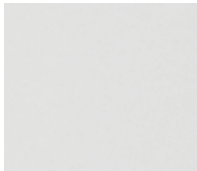

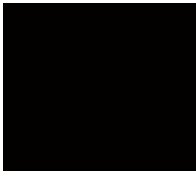

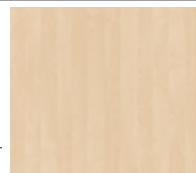
Ball locker

Ball locker stores all kinds of balls and other sport equipment in gyms and sport facilities. Four high-adjustable shelves with raised edges ensure the balls will stay in the locker.

Ball lockers are made from laminate chipboard 18 mm thick which have one fixed shelf and two adjustable shelves for better flexibility.

In case of needs we are able to deliver shelves separately. All edges are covered by ABS edge thick 2 mm.

		COLOR				
						
		steel grey (RAL 7035)	steel blue (RAL 5005)	steel black (RAL 9005)		
EGGER	Kronospan STANDART					
		Maple Mandal	Birch 1715 BS	Nagano Oak 8431 SN	Cherry 0344 BS	Walnut 0729 BS
Kronospan CONTEMPO						
	Concrete Flow K350 RT	Light Rockford Hickory K085 PW	Blonde Surfside Ash K525 SN	Gold Baroque Oak K535 RW	Amber Baroque Oak K536 RW	

An extended range of decors can be found on page 88.



Ball locker	steel	laminite
Height x width x depth (mm)	1970 x 900 x 400	2100 x 1200 x 600
Number of sections	1	1
Equipment	4 height-adjustable shelves, jersey rod	solid shelf, 2 adjustable shelves, turning lock Burg
Weight net / gross (kg)	70 / 75	135 / 143
Order code	IMS-20-A94-XXX-X1	YYAT18-0002-16





Hockey box and multipurpose boxes

Hockey box is made of laminated chipboard and is designed for locker rooms in hockey arenas. However, it can be used elsewhere, where there is no need for standard lockers.

Hockey box is offered in two versions: with open or closed space under the seat. One lockable box with a slot for quick storage is included as well as two double hooks and two shelves.

The hockey box is designed for up to two persons.

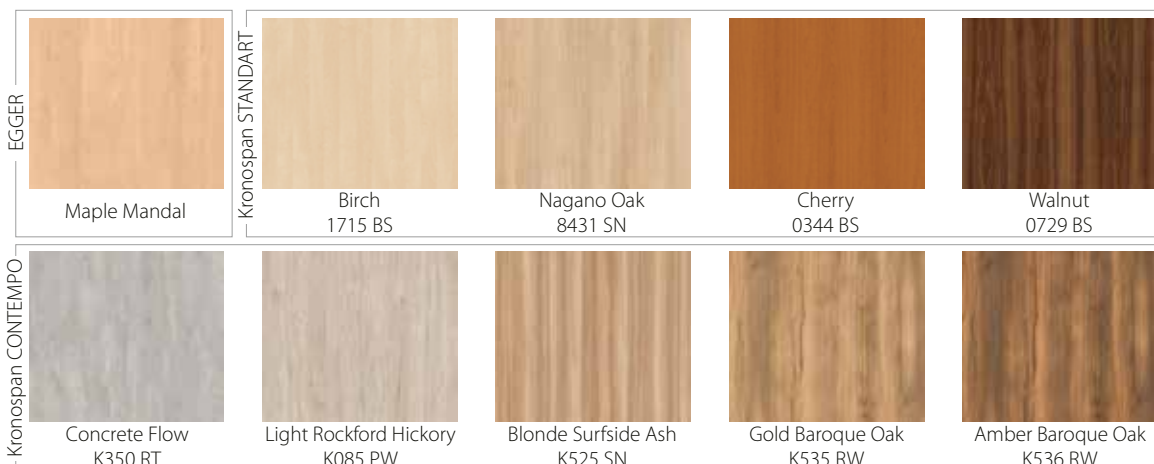

An extended range of decors can be found on page 88.



Hockey box and multipurpose boxes		
Height x width x depth (mm)	1970 x 800 x 600	1970 x 800 x 600
Number of sections	1	1
Equipment	2x shelf, 1x box, 2x double hooks, open space under the bank (seat)	2x shelf, 1x box, 2x double hooks
Weight net / gross (kg)	63 / 68	67 / 74
Order code	IAH-20-B86-XXX-X0	IAH-20-B86-XXX-X1



The HPL universal box is made from high pressure laminate which is extremely durable to destruction and ideal for all the professional and semi-professional clubs. Two variants are proposed.

Player variant with a width of 800 mm and goalkeeper's version with a width of 1000 mm. As this is an exclusive affair, we offer a wide range of decors to meet the demands of all clubs on their color combinations.



HPL hockey box

Height x width x depth (mm)	2180 x 800 x 650	2180 x 1000 x 650
Equipment	2x shelf, 3x hooks, storage space under the seat	2x shelf, 3x hooks, storage space under the seat
Weight net / gross (kg)	90 / 96	107 / 113
Order code	NPAT18-0002-11 hockey player	NPAT18-0002-01 hockey goalkeeper







Fredericia Idrætscenter



HC Warnsdorf



HC Dynamo Pardubice



HC AZ Havířov



HC Dynamo Pardubice

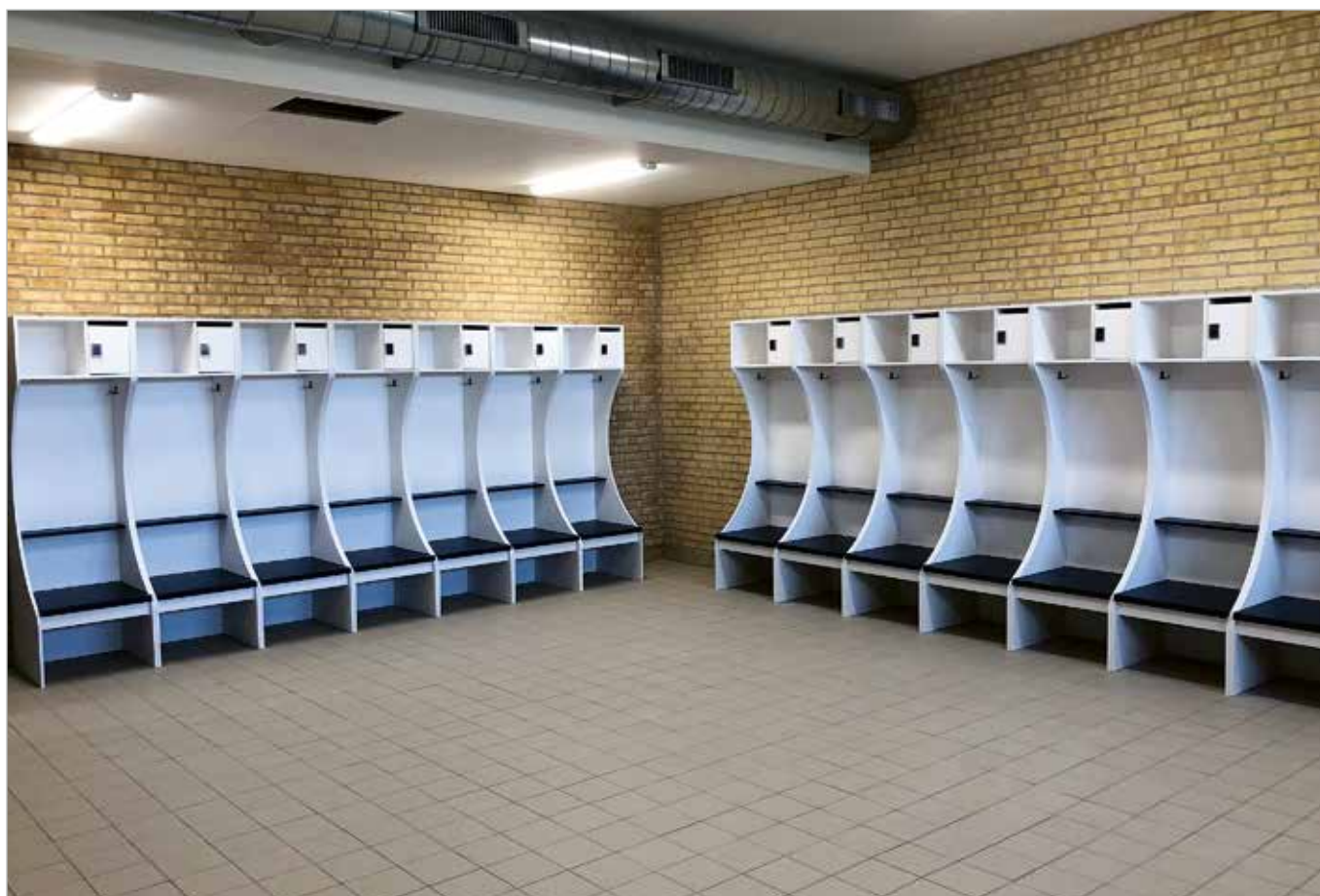

Vendsyssel FF



Vendsyssel FF



Vendsyssel FF



HC Poděbrady



Umeå FC



Ski and snowboard lockers

Ski and snowboard lockers are designated for ski equipment storage in hotels, pensions and ski-depots in ski areas.

The lockers are characterised by welded steel frame, which is powder coated. Back panel is ready to be equipped with efficient drying system.

Special perforation in the door and back side provides air circulation inside the locker.

Option with 2/3 shelf allows you to put in longer objects to use the full height of the locker.

The lockers can be equipped with zinc-coated drip tray or grid.

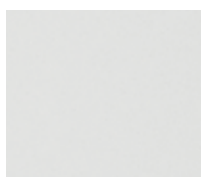

steel grey
(RAL 7035)



steel blue
(RAL 5005)

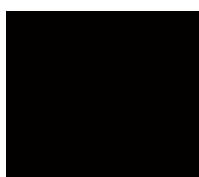

steel black
(RAL 9005)

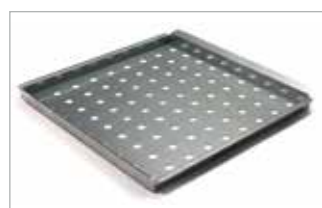

- NLAT20-0005-66 – Removable Drip Tray SKI 320x600, oblique
- NLAT20-0005-67 – Removable Drip Tray SKI 520x600, oblique
- NLAT20-0005-68 – Removable base grid SKI 320x600
- NLAT20-0005-69 – Removable base grid SKI 520x600



Ski and snowboard lockers

Height x width x depth (mm)	2155 x 320 x 600	2155 x 520 x 600
Number of sections	1	1
Equipment	1 x shelf	1 x shelf
Weight net / gross (kg)	44 / 49	54 / 58
Order code	LSS-21-A36-XXX-X2 - zinc-coated	LSS-21-A56-XXX-X2 - zinc-coated
Order code 2/3 shelf	LSS-21-A36-XXX-X3 - zinc-coated	LSS-21-A56-XXX-X3 - zinc-coated

Drying systems

The drying systems for shoes, ski boots and rubber boots operate on the continuous circulation of hot air, which is blown onto the drying objects in the locker. The air temperature is around 45°C (ambient temperature 15°C - 25°C) and is perfect for fast, hygienic and safe drying. Every dryer has an analogue timer with settings for 1-120 minutes of operation.

These drying systems have a wide range of applications in a variety of businesses and organisations such as fire stations, chemical laboratories, construction companies, industrial companies, agricultural facilities, hotels, cottages, fishing clubs, army facilities, police stations, sports clubs and many more.

The purpose of use: boot dryer, ski boots dryer, rubber boots dryer, drying locker.





Hotel Harmony



Bergbahnen Belalp Blatten



Deep Pec pod Sněžkou



Hause Chappelle in Ulrichen



Hotel Svatý Vavřinec



Orea Resort Horal



Orea Resort Horal



Orea Resort Horal



Grandhotel Hradec, Pec pod Sněžkou



Fire lockers and lockers for rescue services

Clothes lockers especially made for firefighters and rescue services.

Lockers have a welded body made of 1 mm steel. Their open construction allows immediate access to the stored clothing

whenever needed.

Feet can be purchased separately, as well as a special tilting helmet holder. Holder can be easily pulled and the helmet removal is simple.



Order code: IAI-02-XXX-IXX-T1



Order code: IAI-01-XXX-XXX-X1



Steel red
(RAL 3000)



IPA



IPB

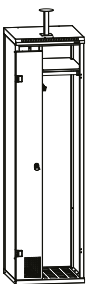

IPA	
Height x width x depth (mm)	1780 x 500 x 500
Number of sections	2
Equipment	2 x shelf, rod, helmet holder, 3 x steel clothes hooks
Weight net / gross (kg)	48 / 53
Order code	IPA-18-A55-IIR-X1 (mechanical code lock), IPA-18-A55-IIC-X1 (cylindrical lock)

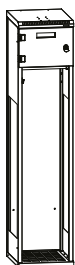

IPB	
Height x width x depth (mm)	1780 x 400 x 500
Number of sections	1
Equipment	1 x lockable box, rod, 3 x steel clothes hooks, special air system between lockers (perforation in side panels)
Weight net / gross (kg)	41/46
Order code	IPB-18-A45-IIC-X2 (cylindrical lock), IPB-18-A45-IIR-X2 (mechanical code lock)



IPC



IPD

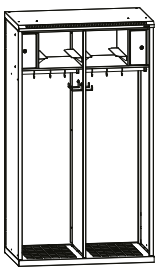

IPC	
Height x width x depth (mm)	1780 x 1000 x 600
Number of sections	2
Equipment	chrome rod with hooks, inner helmet holder, belt hooks, lockable storing boxes
Weight net / gross (kg)	71 / 78
Order code	IPC-18-A16-IIR-D2 (mechanical code lock), IPC-18-A16-IIC-D2 (cylindrical lock)

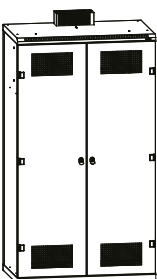

IPD	
Height x width x depth (mm)	1780 x 1000 x 600
Number of sections	2
Equipment	chrome rod with hook, inner helmet holder, belt hooks, lockable storing boxes, dryer (energy consumption 500 W/H)
Weight net / gross (kg)	95 / 101
Order code	IPD-18-A16-IIC-D2(cylindrical lock), IPD-18-A16-IIR-D2 (mechanical code lock)



IPO



IPS

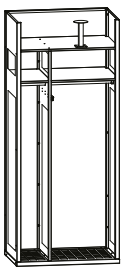

IPO	
Height x width x depth (mm)	1780 x 750 x 500
Number of sections	2
Equipment	rod, helmet holder, 3x steel clothes hooks, special perforation
Weight net / gross (kg)	49 / 55
Order code	IPO-18-X75-IIX-X1

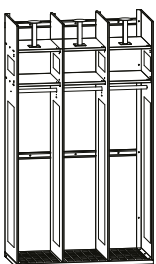

IPS		
Height x width x depth (mm)	1780 x 1000 x 500	
Number of sections	3	
Equipment	rod, 3x helmet holder, special perforation	
Weight net / gross (kg)	48 / 55	41 / 48
Order code	IPS-18-X15-IIX-ZX	IPS-18-X15-IIX-DX without one side wall

IPS lockers are made to be fixed to the wall and are delivered unassembled in packaging of ca 180 x 350 x 550 mm.



IPE – X1

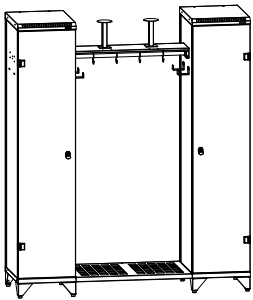

IPE (X1)	
Height x width x depth (mm)	1780 x 1600 x 500
Number of sections	2
Equipment	chrome rod with hooks, helmet holder, 2 clothes/belt hooks, galvanized steel grate in locker: chrome rod, 2 clothes hooks, 3 doublehooks, 2 shelves
Weight net / gross (kg)	100/ 106
Order code	IPE-18-A85-IIC-X1 (cylindrical lock) IPE-18-A85-IIR-X1 (mechanical code lock)

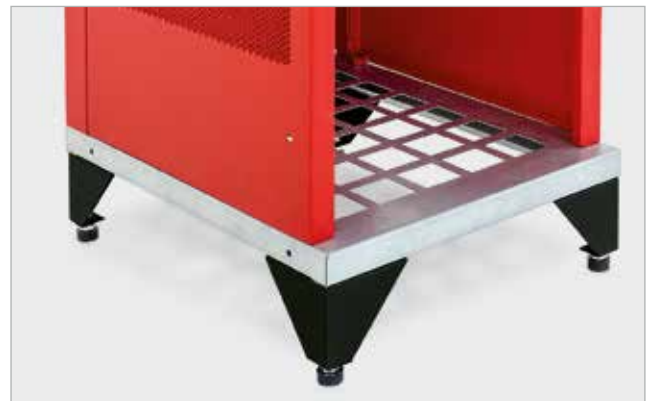



IPE – X2



IPF

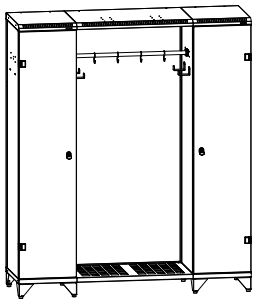

IPE (X2)	
Height x width x depth (mm)	1780 x 1600 x 500
Number of sections	2
Equipment	1 chrome rod, 2 clothes hooks, galvanized steel grate for shoes, belt hook, preparation for helmet holder on top of the locker 1 lockable locker with chrome rod, 2 clothes hooks, 3 doublehooks, 2 shelves, special perforation
Weight net / gross (kg)	113 / 119
Order code	IPE-18-A85-IIC-X2 (cylindrical lock) IPE-18-A85-IIR-X2 (mechanical code lock)

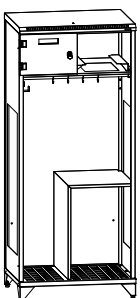

IPF	
Height x width x depth (mm)	1780 x 800 x 600
Number of sections	2
Equipment	1 lockable box, inner helmet holders, chrome rod, 4 clothes hooks, 2 hooks on side inside the locker
Weight net / gross (kg)	62 / 68
Order code	IPF-18-A86-IIC-X1 (cylindrical lock) IPF-18-A86-IIR-X1 (mechanical code lock)



Feuerwehr Buochs Ennetbürgen



Freiwillige Feuerwehr Erpfting



Freiwillige Feuerwehr Munchehof



Feuerwehr Wallenwil/Eschlikon



ZOO Hluboká nad Vltavou



Bayerisches Rotes Kreuz



Bayerisches Rotes Kreuz



Nordic Lockers



Van Akelyen

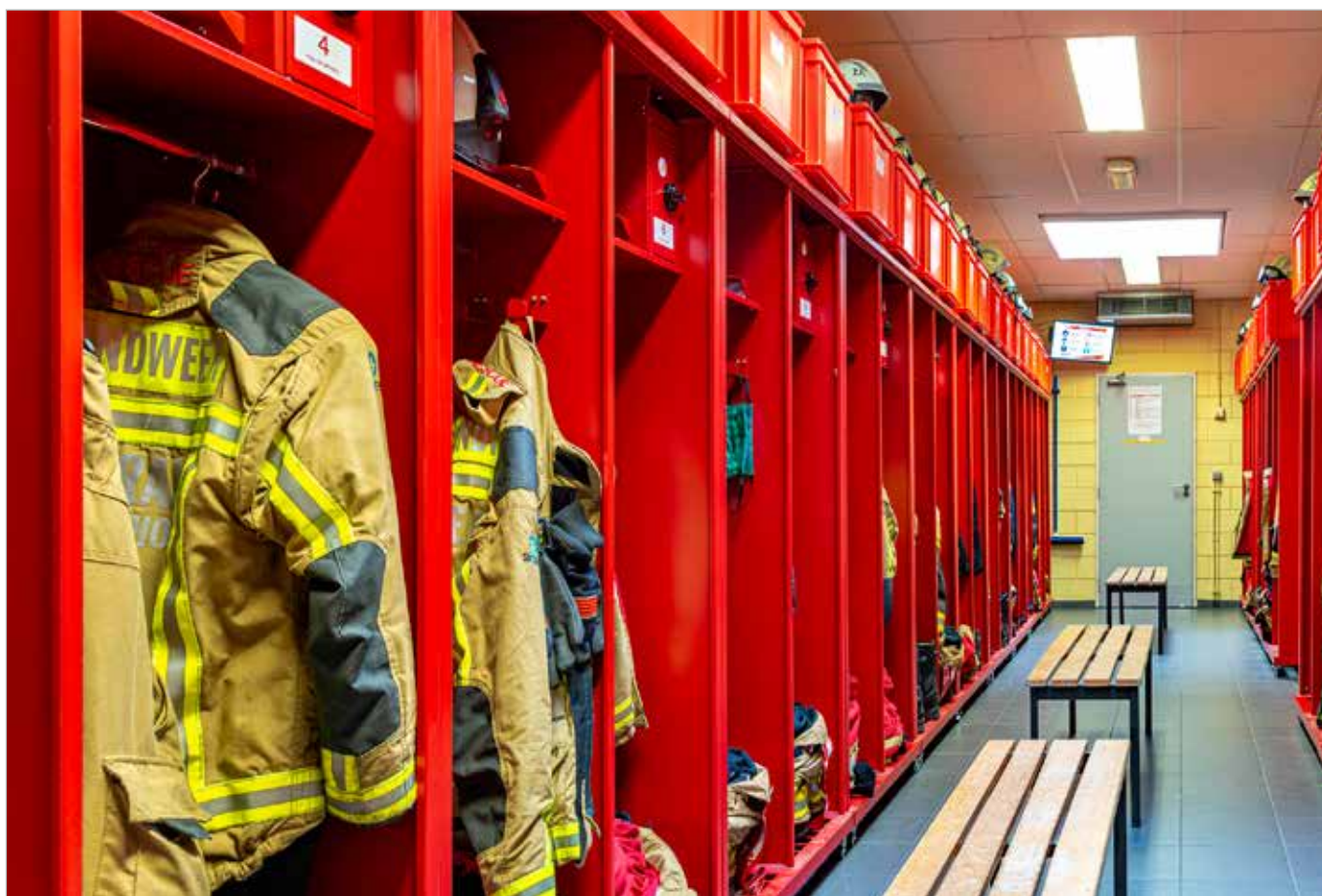

Brandweer Zandhoven













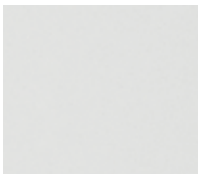

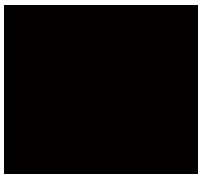
Key lockers

Steel key lockers

with hardened glass door are used for perfect key management. The locker can be easily mounted to the wall. Hooks are made of steel.

Laminated chipboard key locker

is made in maple decor and carries hooks made of steel. The locker is fitted with cylindrical lock for safe key-storage.

	COLOR					
						
	steel grey (RAL 7035)	steel blue (RAL 5005)	steel black (RAL 9005)			
EGGER		Kronospan STANDART				
	Maple Mandal		Birch 1715 BS	Nagano Oak 8431 SN	Cherry 0344 BS	Walnut 0729 BS
Kronospan CONTEMPO						
	Concrete Flow K350 RT	Light Rockford Hickory K085 PW	Blonde Surfside Ash K525 SN	Gold Baroque Oak K535 RW	Amber Baroque Oak K536 RW	

An extended range of decors can be found on page 88.



Key lockers

Height x width x depth (mm)	670 x 370 x 105	670 x 620 x 105	990 x 620 x 105
Number of hooks	50 hooks (5 x line / 10 pcs)	100 hooks (5 x line / 20 pcs)	160 hooks (8 x line / 20 pcs)
Weight (kg)	8	12	18
Order code	IAK-06-C41-XXX-X1	IAK-06-C61-XXX-X1	IAK-09-C61-XXX-X1



Laminated chipboard key locker

Height x width x depth (mm)	615 x 310 x 125	615 x 560 x 125	950 x 560 x 125
Number of hooks	50 hooks (5 x line / 10 pcs)	100 hooks (5 x line / 20 pcs)	160 hooks (8 x line / 20 pcs)
Weight (kg)	8	13	18
Order code	LAK-06-B31-CAA-X1	LAK-06-B51-CAA-X1	LAK-09-B51-CAA-X1



Cloakroom seats

Steel sheet and laminated chipboard combination

Cloakroom seats for plants, gyms, schools, and sport facilities.

The frame is made of sturdy 30 x 30 mm steel profiles and the seat is laminated chipboard with 2mm ABS edging.

Feet are fitted with plastic gliders. Cloakroom seats can be made in versions with hooks.



If requested, the frame can be adjusted for storing shoes.



An extended range of decors can be found on page 88.



One-sided cloakroom bench with hooks

Height x length x depth (mm)	1800 x 1200 x 430	1800 x 1500 x 430	1800 x 2000 x 430
Number of hooks	8	10	13
Weight net / gross (kg)	67	75	89
Order code	ITV-04-X01-XXX-X3	ITV-04-X02-XXX-X3	ITV-04-X03-XXX-X3

Double-sided cloakroom bench with hooks

Height x length x depth (mm)	1800 x 1200 x 430	1800 x 1500 x 430	1800 x 2000 x 430
Number of hooks	16	20	32
Weight net / gross (kg)	111	121	150
Order code	ITV-08-X01-XXX-X3	ITV-08-X02-XXX-X3	ITV-08-X03-XXX-X3



Cloakroom seat

Height x length x depth (mm)	460 x 1200 x 350	460 x 1500 x 350	460 x 2000 x 350	460 x 2000 x 550
Weight (kg)	14	18	25	26
Order code	ITL-04-X03-XXX-X2	ITL-04-X04-XXX-X2	ITL-04-X05-XXX-X2	ITL-04-X01-XXX-X2



NEW

Whole laminated wardrobe bench

The whole laminated bench is made of durable laminated chipboard with a thickness of 36 mm with a 2 mm ABS edge. Thanks to the materials used and the design, these benches are especially suitable for spaces where high demands are placed on the overall design of the dressing room.



Xxxxx			
Height x length x depth (mm)	460 x 600 x 350	460 x 800 x 350	460 x 1000 x 350
Weight (kg)	14	16	18
Order code	ILL-04-X01-XXX-X1	ILL-04-X02-XXX-X1	ILL-04-X03-XXX-X1

EGGER		Kronospan STANDART				
	Maple Mandal		Birch 1715 BS	Nagano Oak 8431 SN	Cherry 0344 BS	Walnut 0729 BS
Kronospan CONTEMPO						
	Concrete Flow K350 RT	Light Rockford Hickory K085 PW	Blonde Surfside Ash K525 SN	Gold Baroque Oak K535 RW	Amber Baroque Oak K536 RW	

An extended range of decors can be found on page 88.



NEW

Design self-watering flowerpot

Environment: Exterior / Interior

Colour: antracit RAL 7016

Material: zinc coated steel treated with facade powder coating

Dimensions: 875 x 850 x 300 mm (W x H x D)

Included: 3x self-watering plastic set, 2x wheels, 2x rectifying feet

Weight: 23 kg (including plastic inner liners)

Plastic inner liner with self-watering set

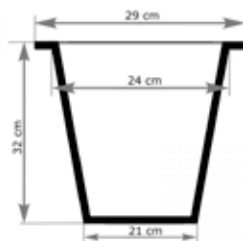

This set consists of:

- from the inner plastic liner
- double bottom (partitions)
- water status indicators

High-quality and stable plastic is used for the inserts, so they can be used indoors and outdoors.

Inner flower liners:

3 x self-watering plastic set in black with water level indicator.



Easy handling:

2 wheels for movement and 2 rubber feet to prevent spontaneous movement.

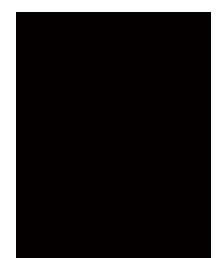

steel black (RAL 9005)

Also can be ordered:

Set of sheet metal profiles for anchoring the flowerpot (including connecting material).



Shelf racks

Shelf racks

Universal mounted rack for archives, workshops and warehouses. Shelves can be adjusted, each by 45 mm.

Loading: 100 kg
Max. loading capacity: 500 kg

It comes disassembled into individual components.

Welded shelf racks - steel / laminated chipboard

Shelves made of 18 mm thick laminated chipboard and fitted into a steel frame. We recommend the shelf rack to be mounted to a wall.

Loading capacity: 75 kg
Max. loading capacity: 450 kg



An extended range of decors can be found on page 88.



Shelf racks				
Height x width x depth (mm)	2000 x 1000 x 400	2000 x 1000 x 500	2000 x 1000 x 400	2000 x 1000 x 500
Surface treatment	zinc-coated	zinc-coated	colour	colour
Equipment	5 x shelf	5 x shelf	5 x shelf	5 x shelf
Weight net / gross (kg)	38 / 39	44 / 45	29 / 30	34 / 35
Order code	IAR-20-X14-XXX-X1	IAR-20-X15-XXX-X1	IAR-20-X14-CCX-X1	IAR-20-X15-CCX-X1

Welded shelf racks - steel / laminated chipboard	
Height x width x depth (mm)	2000 x 1000 x 500
Surface treatment	laminate
Equipment	6 x shelf
Weight net / gross (kg)	63 / 69
Order code	IDR-20-X15-XXX-X1





Workbenches

Universal and flexible workbench for workshops, school classrooms, warehouses and garages.

Adjustable feet for adjusting the height of the working desk in 50 mm increments from 655 mm up to 1005 mm.

Supplied table lengths (mm): 750, 1200, 1500, 1700, 2000

Depth for all table lengths (mm): 700

Table loading capacity (kg): 500 at even load

Workspace: solid beech battenboard with a thickness of 40 mm, chamfered top edges

Fixed profiled base: welded from steel profiles, rear traverse for higher rigidity

Surface treatment of metal profiles: powder coating - gray RAL 7035

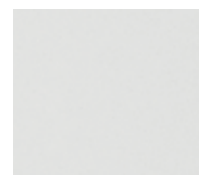

steel grey
(RAL 7035)



steel blue
(RAL 5005)





Workbenches					
Height (mm)	750	1 200	1 500	1 700	2 000
Width x depth (mm)	655 – 1005 x 700	655 – 1005 x 700	655 – 1005 x 700	655 – 1005 x 700	655 – 1005 x 700
Order code					
RAL7035	CXAT20-0056-05	CXAT20-0056-04	CXAT20-0056-03	CXAT20-0056-02	CXAT20-0056-01
RAL 5005	UXAT20-0056-05	UXAT20-0056-04	UXAT20-0056-03	UXAT20-0056-02	UXAT20-0056-01

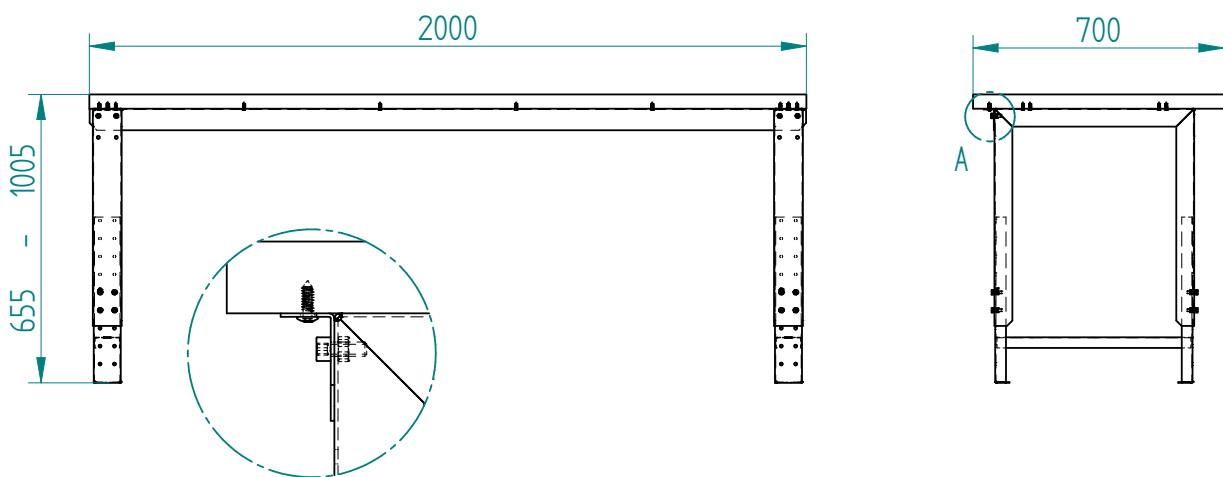



Container

Container with door and shelf

1 x shelf

Door in RAL 5005 with magnets, cabinet RAL 7035.

Opening the door from left to right and vice versa can be easily interchanged.

Internal adjustable shelf with 21.5 mm grille, fastened with 4 M5 screws, upper chamber light from 105 to 190 mm.

Container with drawers

4 x socket

1 x upper drawer - internal height 80 mm

3 x bottom drawer - internal height 130 mm

telescopic drawer extension - 100%

load capacity of drawers 45 kg

Powder coating of the container varnish gray / blue, RAL 7035/5005.



	Order Code	Dimensions W x H x D	Weight (kg)	Color
Workshop table container 4 x drawer	BXAT20-0056-14	570 x 600 x 550	40	black skeleton, black sockets
Workshop table container 4 x drawer	CXAT20-0056-14		40	gray skeleton, gray drawers
Workshop table container - door	CUAT20-0056-20		26	gray skeleton, blue door

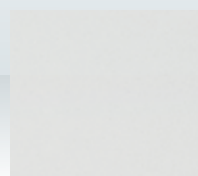

steel grey
(RAL 7035)



steel blue
(RAL 5005)

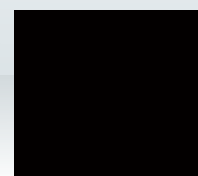

steel black
(RAL 9005)



Additional steel production and cooperation

Mobile patient locker

The locker is fitted with a lockable box to store personal belongings.

It is also equipped with two handles and four wheels (two with breaks) for easy manipulation.

Easy cleaning is ensured by the smooth finish.





Multipurpose storage box

The multipurpose storage box has been designed to store mainly small items such as wallets, cell phones and other valuables that you want to keep safe during any activities. It comes with a Burg lock that ensures trouble-free security so you can store away your personal belongings without any concerns.



Referee table

The laminate referee table is suitable for any sport venue. It has a spacious table top containing a grommet allowing easy access to power for electronic devices. Its wheels with brakes ensure easy handling.



Shoe locker

2-door shoe locker intended to be placed under seats of clothes lockers. The boxes can be put one on each other and fix them with screws.

Dimensions: 410 x 512 x 600 mm

Use: intended to be placed under seats of clothes lockers

Locking: 2x cylindrical lock with 2 keys (possibility of turning lock for padlock)

Frame: welded with perforation

Weight: 14 kg

Order code: IAB-04-C56-XXX-X1



Light frames



Steel bedside cabinets



Material

The wall with modules is made of high quality powder coated steel sheet with a smooth surface. The surface is very easy to maintain and durable.

Installation

Easy assembly by simply sliding the hooks onto the the back of the boxes into the holes in the main plate and secured with a screw joint.



USAGE:



HEALTH CARE



INDUSTRY



GOVERNMENT



SCHOOL



BLOCKS OF FLATS

Multifunctional storage wall

for flyers, keys, medications, mail, defibrillator

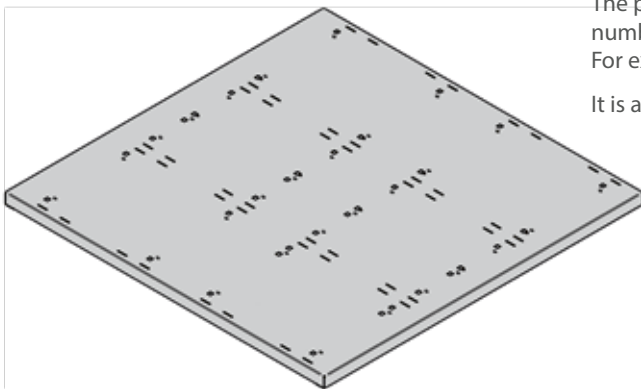

The plate allows easy fixing of various types of boxes in different number combinations.

For example, it can contain only 4 mail boxes and 4 flyer modules.

It is always supplied only in a specific combination.

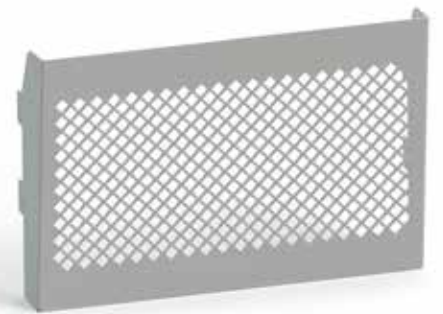

Colour

Hanging modules and plate are supplied in two-colour combination grey/blue or grey/black.

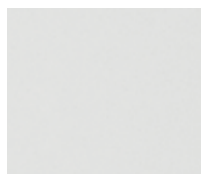

steel grey
(RAL 7035)



steel blue
(RAL 5005)

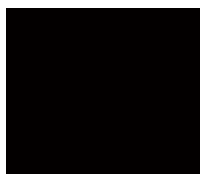

steel black
(RAL 9005)

Modules:

FOR FLYERS
IUS-PR-XXX-XXX-X1

Dimensions

width 285 mm
height 190 mm
depth 54 mm

Weight

0,46 kg

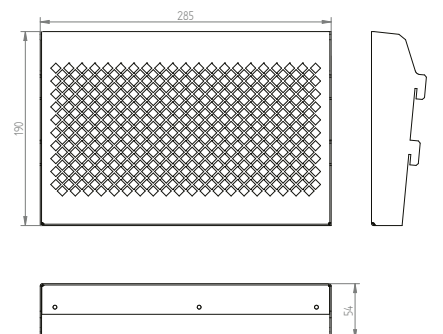

FOR KEYS
IUS-04-K38-XXX-X1

Dimensions

width 300 mm
height 400 mm
depth 60 mm

Weight

3,96 kg

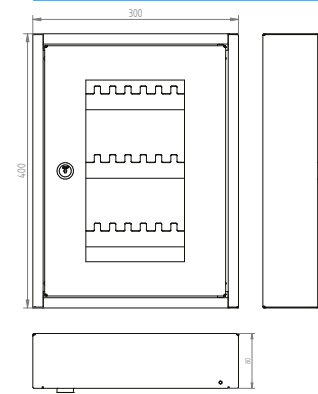

FOR MEDICATIONS
IUS-04-L31-XXX-X1

Dimensions

width 300 mm
height 400 mm
depth 120 mm

Weight

4,00 kg

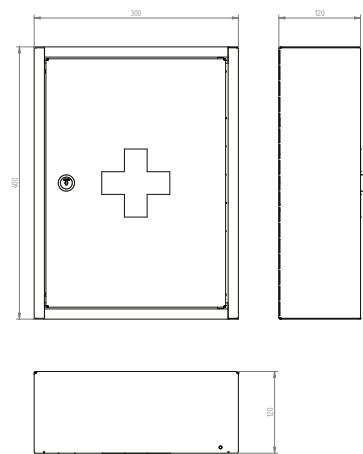

FOR MAIL
IUS-04-P38-XXX-X1

Dimensions

width 300 mm
height 400 mm
depth 60 mm

Weight

3,26 kg

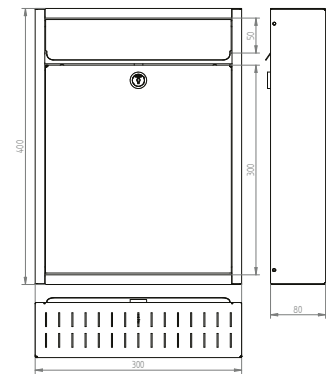

FOR A DEFIBRILLATOR
IUS-04-D52-XXX-X1

Dimensions

width 500 mm
height 400 mm
depth 200 mm

Weight

8,19 kg

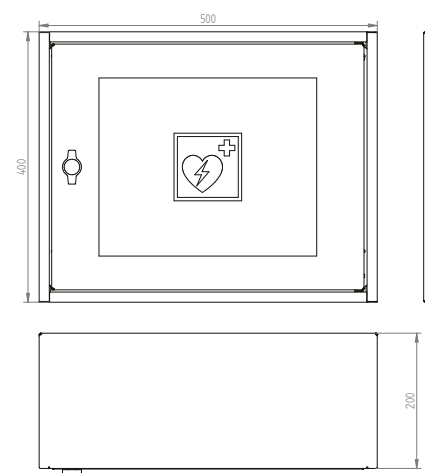

Mail box for smart pickup larger parcels from shipping companies without the presence of the recipient.

The box is locked with a numerical code lock allowing the courier to securely deposit of the parcel using the unique code provided by the recipient.

The box is available in 3 sizes.

All boxes are equipped with levelling feet and holes in the back wall for anchoring to the wall.



**ANTI-Covid
PROGRAM**

Mail box

Optionally, a digital lock can be installed that can be touch-sensitive with up to an 8-digit code, or touch-sensitive with code and fingerprint reader + Bluetooth for remote control via an app on your mobile device.



Colour

The mail box can be ordered in one colour or two-colour combination according to the pattern.

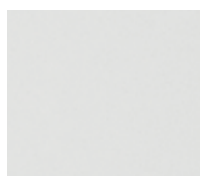
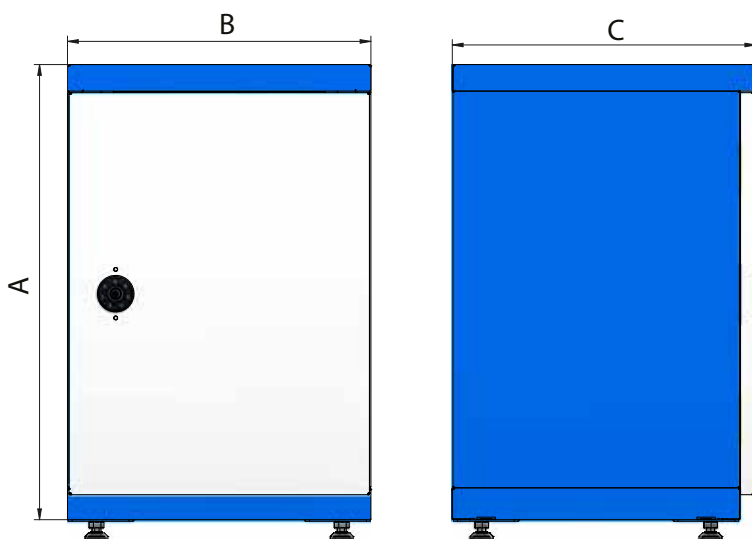

steel grey
(RAL 7035)



steel blue
(RAL 5005)



steel black
(RAL 9005)

type	A	B	C	weight
	(mm)			(kg)
IBP-06-A44-XXX-X1	600	400	400	13
IBP-06-A54-XXX-X1	650	500	450	16,21
IBP-10-A66-XXX-X1	1000	600	650	28,54

Použití:

HEALTH
CARE

INDUSTRY



GOVERNMENT



SCHOOL

BLOCKS OF
FLATS

Fully automatic disinfectant dispenser with a motion sensor.

The base of the stand is made of sheet metal thickness 4 mm, stand profile made of sheet metal thickness 2 mm, welded construction is non-detachable.

ANTI-Covid
PROGRAM

Stand for Disinfectant Dispenser

Order Code: IDS-14-X43-XXX-X1

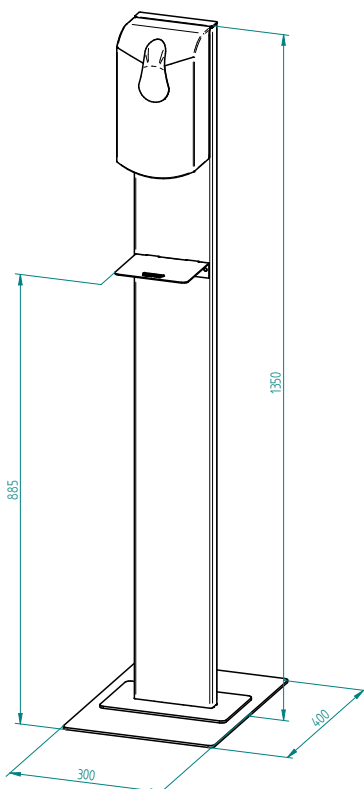
**Dimensions:**

width 300 mm
height 1350 mm
depth 400 mm

Weight:

10,48 kg

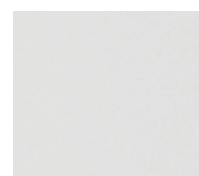
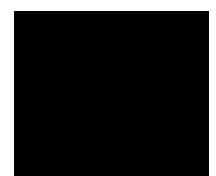
steel grey
(RAL 7035)steel blue
(RAL 5005)steel black
(RAL 9005)

Usage::



HEALTHCARE



INDUSTRY



GOVERNMENT



SCHOOL



BLOCKS OF
FLATS

There are two types to choose from disinfectant dispensers : manual or fully automatic with a motion sensor.

Module for the graphic allows you to insert and easily exchange information leaflets in A4 format.



Hygienestand

including waste basket

with preparation for flexible installation of different types of modules:

Module for the graphic

Module for paper towels

Module for the face masks

Module for tissues or gloves

Disinfectant dispenser

Hanging modules and plate are supplied in two-colour combination grey/blue or grey/black.

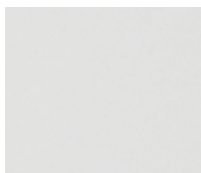

steel grey
(RAL 7035)



steel blue
(RAL 5005)

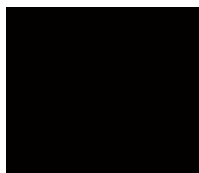

steel black
(RAL 9005)



**ANTI-Covid
PROGRAM**

Modules

FOR PAPER TOWELS

IDS-PR-XXX-XXX-P4



FOR TISSUES OR GLOVES

IDS-PR-XXX-XXX-P2



FOR THE FACE MASKS

IDS-PR-XXX-XXX-P1



FOR THE GRAPHIC

IDS-PR-XXX-XXX-P3



The plate allows easy fixing of modules with the included screws and nut into the prepared holes.

DISINFECTANT DISPENSER



Manual dispenser
Merida TOP -Spray



Automatic dispenser
AUTOMATIC Merida ONE

STAND INCLUDING WASTE BASKET

IDS-16-X45-XXX-X1

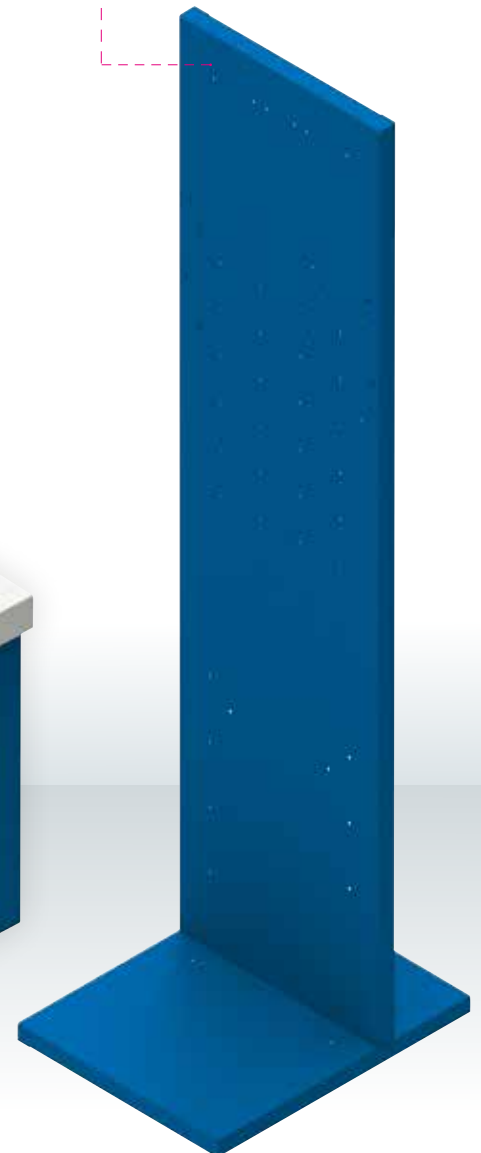

Dimensions:

width 400 mm
height 1600 mm
depth 500 mm

Weight:

16,2 kg including waste basket



Accessories

Our customers can choose from a wide variety of locker accessories.

Shelves - Steel, Laminate

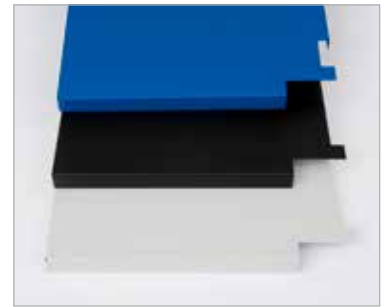

COLOR			
	steel grey (RAL 7035)	steel blue (RAL 5005)	steel black (RAL 9005)

EGGER		Kronospan STANDART				
	Maple Mandal		Birch 1715 BS	Nagano Oak 8431 SN	Cherry 0344 BS	Walnut 0729 BS
Kronospan CONTEMPO						
	Concrete Flow K350 RT	Light Rockford Hickory K085 PW	Blonde Surfside Ash K525 SN	Gold Baroque Oak K535 RW	Amber Baroque Oak K536 RW	

An extended range of decors can be found on page 88.

Plastic shoe pad

Dimensions: 270 x 345 mm
IZN-PV-X23-XXX-X1



Hook „S“

IZN-SS-X03-XXX-X1 - black plastic
IZN-SS-X07-XXX-X2 - steel

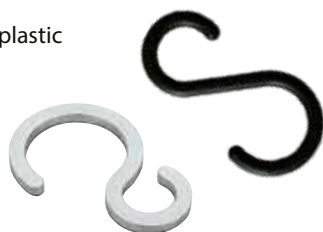

Metal hook „9“

IAI-06-XXX-ZXX-X1



Power distribution units

DIN: RAB-PD-X91-C1
ČSN: RAB-PD-X90-C1



Roof 15°

IAN-01-XX5-XXX-X1



Levelling feet

included in a supply



Connecting set

RAX-MS-X70-X1



Key number tags

Key numbering 01-50:

IZN-SS-X02-XXX-X2

Key numbering 001-100:

IZN-SS-X02-XXX-X3

Stainless steel

key numbering 001-100:

IAI-03-XXX-NXX-X11



Self-adhesive label

IZN-SS-X01-XXX-X2 - blue

IZN-SS-X01-XXX-X3 - black





Locks

Digilock®

Company Digilock has been estimated 1981 in California. Nowadays is proudly on quality workmanship that simplifies security and improves user experience through innovation, quality and design for which is sought.

BURG®

BURG represents the fourth generation of the family business, whose history goes back to 1890, when the first padlock has been made. Today BURG is a modern supplier of locks for a variety of applications and one of the leading European manufacturers of locking systems. Our specialization are the mechanical and electronic locks for metal and wooden furniture.

Metra.si

Metra is a comprehensive supplier of online locking solutions including readers, touch screens, bar codes, QR codes and software services.

**ACS
Solution**

ACS Solution specializes in comprehensive supplies, especially in the field of electronic access systems for hotels, spas, sports centers, apartment buildings, production halls, health and education facilities.

Digilock®



Digilock AXIS Keypad

Digilock AXIS Keypad Slim

The elegant appearance of the lock Digilock brings a clean design with solution for your locking. The lock is keypad operated with either a fixed or multi-user 4 digit code. This eliminates the necessity of keys, smart bracelets, keychains and cards. Also available in slim version.



Digilock AXIS RFID

Digilock AXIS RFID Slim

The elegant appearance of the lock Digilock brings a clean design with solution for your locking. Access with cards or chip bracelets. The lock is RFID operated with either a assigned or free use. Also available in slim version.



Digilock Cue Keypad

The lock is keypad operated with either a fixed or multi-user 4 digit code. This eliminates the necessity of keys, smart bracelets, keychains and cards.



Digilock Cue RFID

Locks are operated by card or chip bracelet. This lock is battery powered and ensures solid security. The lock is RFID operated with either a assigned or free use.



Digilock SOLA Keypad

Keypad operated with a 4-digit custom code. This lock is battery powered and ensures solid security. This eliminates the necessity of keys, smart bracelets, keychains and cards. Locks can be mounted in vertical or horizontal position.



Digilock SOLA RFID

Locks are operated by card or chip bracelet. This lock is battery powered and ensures solid security. The lock is RFID operated with either an assigned or free use. Can be mounted in vertical or horizontal position.



BURG®

Cylindrical lock Burg - for steel

Locking fixes the door in its central part. As a standard, locks are equipped with two steel keys. Locks can be equipped with a master key system (master key is universal for locks in steel and laminated chipboard as well).

Order code: IZN-ZK-X24-XXX-X1 - right, left lock
 IZN-ZK-X08-XXX-X1 - master key



Cylindrical lock Burg - for laminated chipboard

Locking fixes the door in its central part. As a standard, locks are equipped with two steel keys. Locks can be equipped with a master key system (master key is universal for locks in steel and laminated chipboard as well).

Order code: IZN-ZK-X06-XXX-X1 - right lock
 IZN-ZK-X07-XXX-X1 - left lock
 IZN-ZK-X08-XXX-X1 - master key



Turning lock Burg

Locking with a turning clamp; a padlock is used to fix the lock in the locked position. Recommended diameter of the pad lock shackle is 6 mm.

Order code: IAZ-ZK-X67-XXX-X1 - right lock
 IAZ-ZK-X66-XXX-X1 - left lock



Safety turning lock Burg

Locking with a turning clamp; a padlock is used to fix the lock in the locked position. Recommended diameter of the pad lock shackle is 6 mm. After inserting the padlock shackle, the safety lock spins freely and prevents the forcible spinning of the lock in the assembly hole.

Order code: IAZ-ZK-X53-XXX-X1



Mechanical code lock Burg sPinLock 510

This mechanical code lock has a 4-digit code locking system with the option of a master key. We recommend using this lock in places where the users do not change very often (lockers for fire fighters, golf lockers).

Order code: IZN-ZK-A20-XXX-X1 - right lock
 IZN-ZK-A21-XXX-X1 - left lock
 IZN-ZK-A22-XXX-X1 - master key



Mechanical code lock Burg

This mechanical code lock has a 4-digit code locking system with the option of a master key. We recommend using this lock in places where the users do not change very often (lockers for fire fighters, golf lockers).

Order code: IZN-ZK-X26-XXX-X1 - right lock
 IZN-ZK-X25-XXX-X1 - left lock
 IZN-ZK-X22-XXX-X1 - master key



Coin lock Burg

This lock is designed to accept € 1 coins. Another coin value can be requested as well. The key remains blocked in the lock until the coin is inserted and then the locker is locked. After unlocking, the coin is released and returned or held in a money collecting box and the key remains blocked in the lock again. Coin locks can be equipped with a master key.

Order code: IZN-ZK-X11-XXX-X1 - right lock for € 1
 IZN-ZK-X12-XXX-X1 - left lock for € 1
 IZN-ZK-X13-XXX-X1 - master key



Burg Combi Pad

Keypad operated with a 4-digit or 6-digit custom code. Sturdy full metal anti-vandal lock. Water resistant. Battery lifetime is 60.000 locking cycles. Master key is replaced by master code system.

Objednací kód: IZN-ZK-X29-XXX-X1 - right lock
 IZN-ZK-X30-XXX-X1 - left lock



Burg Corona

Lock is operated by a card or any chip. It is compatible with systems based on 125 kHz frequency or Mifare technology. The lock includes two batteries, LED back light and can be programmed as single or multi-user.

Order code: IAZ-ZK-X60-XXX-X1 - lock for laminated chipboard
IAZ-ZK-X59-XXX-X1 - lock for steel



ACS 19-HU

Locks ACS 19-HU offer assigned or free use. Almost all-metal, very durable construction. Ideal price/performance.



KERONG

Digital sensor lock, which can be operated by a touch by a up to 8-digit code, or by code and fingerprint reader or by RFID and numeric code, fingerprint reader + Bluetooth for remote control using an application on a mobile device.

Order Code: IZN-ZK-A10-XXX-X1 - lock with numeric code
IZN-ZK-A11-XXX-X1 - with numeric code, fingerprint
IZN-ZK-A12-XXX-X1 - RFID with numeric code, fingerprint, Bluetooth

The eco-friendly locker system which saves time, money and stress.

No on-locker management, no broken keys/locks, no need to change harmful lock batteries, etc.

Intelligent, secure, low-maintenance, centrally managed and most user-friendly locker system for storage and delivery lockers in modern offices, smart buildings and other facilities of any size.



Metra electronic lock

Central unlocking of individual lockers
Fully concealed (not visible on doors)
Open locker doors to left, right, up, down and front (for electronic drawers)
Vandal-proof (no direct access to lock)
With Auto-Open, Push-Open or Pull-Open locker door dynamics Electric motor-driven (highly reliable) Self-test at every use (each lock/unlock)



Metra electronic lock with RFID reader

For on-door unlocking lockers
Status lights (vacant, occupied, alarm, etc.)
Open locker doors to left, right, up, down and front (for electronic drawers)
Vandal-proof (no direct access to lock)
With Auto-Open, Push-Open or Pull-Open locker door dynamics
Electric motor-driven (highly reliable)
Self-test at every use (each unlock)



Metra Display

Central unlocking of individual lockers
For daily (random visitors) or long-term locker use (employees, students, etc.)
RFID media/4 -digit PIN Code as locker key
Used as standalone or with Metra Readers
Embedded washable keypad
Built-in RFID reader
4-digit LED display
Used with Metra electronic locks



Metra Touch Display

Central unlocking of individual lockers
For activity-based/co-working type lockers
User occupies a vacant locker by himself
10" touch screen with Full HD resolution
Multilanguage functionality
Custom branding of screens (optional)
For storage and delivery locker system
Horizontal or Vertical position
Used as standalone or with Metra Readers



Metra Reader

For Metra Display/Metra Touch Display
Central unlocking of individual lockers
Enables the use of various locker keys
Use multiple locker keys for single locker
Reader ISO (ISO RFID)
Reader Multi (99,9% of RFID) LE (Legic™ RFID)
Barcode (Barcode, QR Code)
With genuine HID™ Tech. (HID™ RFID)

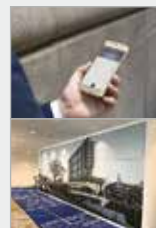

MyMetraKey mobile app

For remote unlocking of individual lockers
For activity-based or long-term lockers
Remote locker use and management Manage multiple lockers from single app
Enables fully clean-line lockers
No Metra Displays/Metra Readers needed
As a sole locker key or in combination with secondary key (PIN code, RFID, etc.) For iOS and Android



Metra Locker Management Software

Complete remote management and overview of all user and locker activities
Remotely add/remove media and users
Remotely unlock any locker or lockers
For various locker solutions (Daily lockers, Rental lockers, Workplace Lockers and Delivery/Parcel lockers)
Detailed reports and statistics (optimizing employee locker usage)

Metra locker system for any solution

Daily lockers (daily guests and visitors)

Rental lockers (renting out lockers)

Workplace lockers (employees, students)

Delivery and Pickup lockers (parcel)

Integrate with any third-party system

Access control, time and attendance, payment, cashless vending, facility, etc.

Project realization

Our company provides complete delivery of your order from consultation and production of your chosen product to transport with our fleet or contract carrier including unpacking and placing lockers at the desired location.

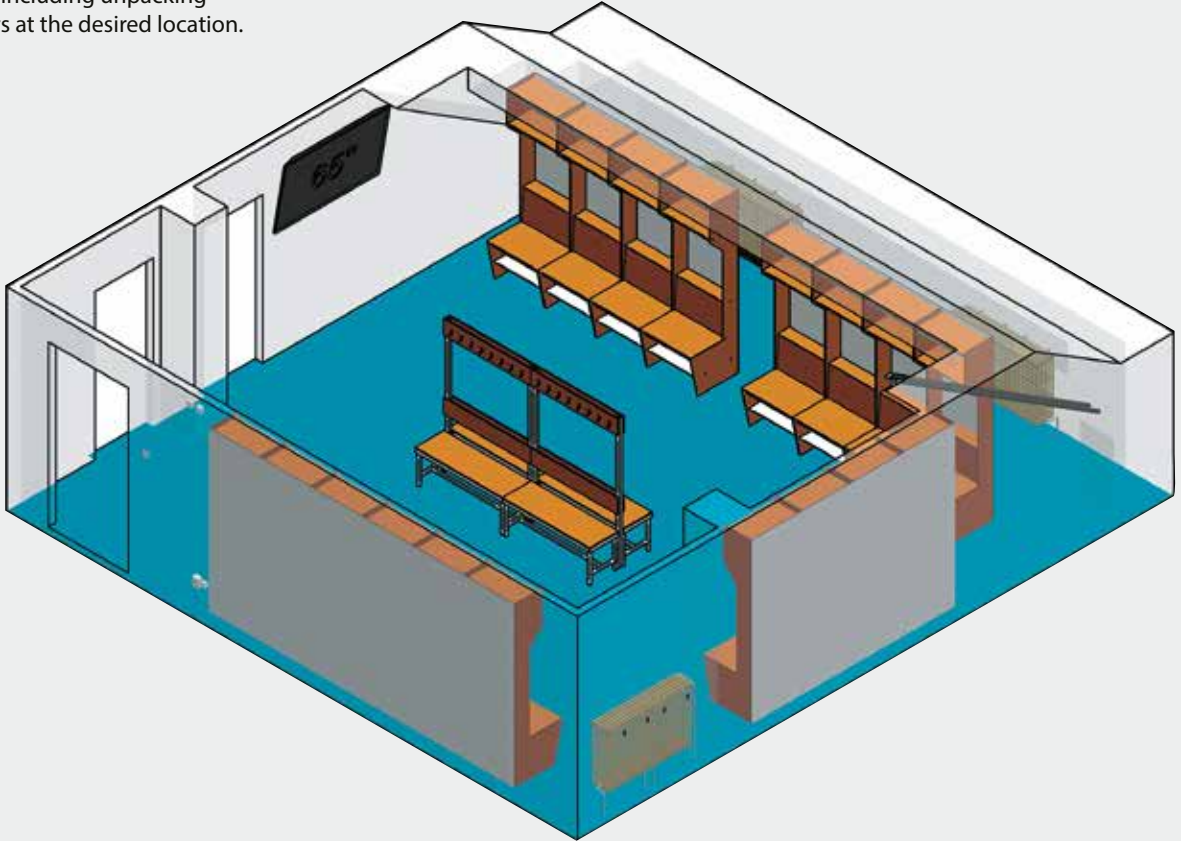

Technical support

We will be pleased to provide you with expert assistance in selecting the right product. Based on your specific requirements, we propose the most appropriate dimension, construction and optional locking system. If needed, we will measure your desired area and develop graphic design solutions.

Production

Own production on automated CNC machines which increases the quality and accuracy of our product. The most important thing for us is to meet customer demands and therefore we offer all additional equipment as marking of lockers, keys, hooks, nivelation feets and others which are part of the order.

Transport

We use our own fleet or contracted carriers to transport our products. According to the place of implementation and shipping order dimensions, we choose the best method of transport. Many projects are implemented in places where a tailgate is needed for unloading goods.



Assembly

The final step to successfully complete the projects is to unpack and place the lockers. All packaging material will be taken back with us.

The offer of Kronospan Contempo decors

NEW



K349 RT
Silk Flow



K524 SN
Pure Surfside Ash

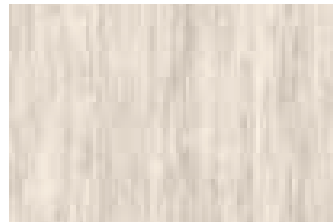

K083 SN
Light Artwood

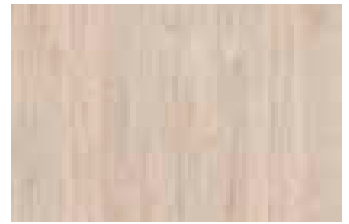

K085 PW
Light Rockford Hickory



K543 SN
Sand Barbera Oak

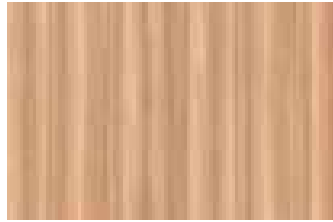

K525 SN
Blonde Surfside Ash



K358 PW
Honey Castello Oak



K360 PW
Vintage Harbor Oak

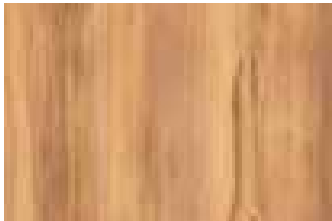

K535 RW
Gold Baroque Oak



5527 SN
Stone Oak

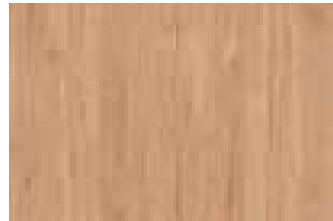

K086 PW
Natural Rockford Hickory



5501 SN
Slavonia Oak

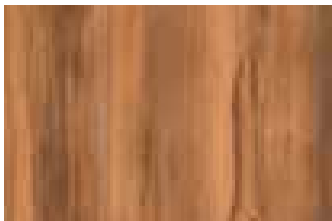

K536 RW
Amber Baroque Oak

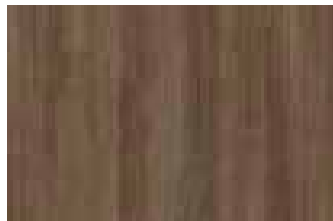

K548 RW
Smoked Kala Ash



K546 RW
Caramel Franklin Walnut

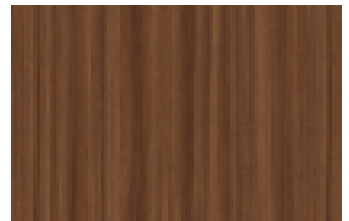

K547 RW
Tobacco Franklin Walnut

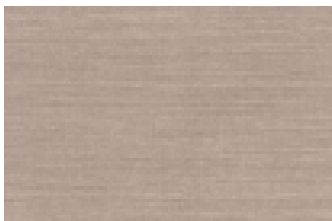

K541 PN
Greige Tessea

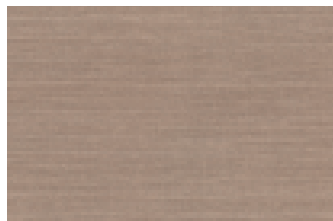

K542 PN
Mocha Tessea



K084 SN
Dark Artwood



K538 PN
Dovetail Arosa

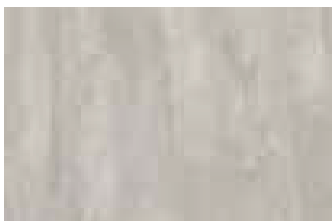

K350 RT
Concrete Flow

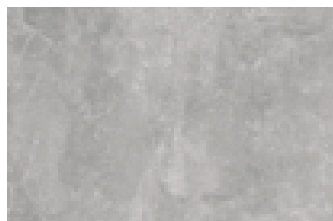

4298 SU
Light Atelier



K540 PN
Grey Albus

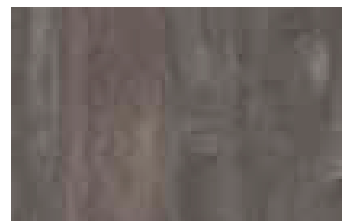

K352 RT
Iron Flow



K022 SN
Satin Blackwood



K107 PW
Elegance Endgrain Oak

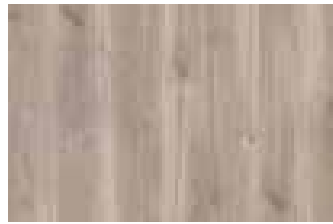

K357 PW
Greige Castello Oak



K355 PW
Platinum Grange Oak



K105 PW
Raw Endgrain Oak



K544 RW
Hazel Silverjack Oak

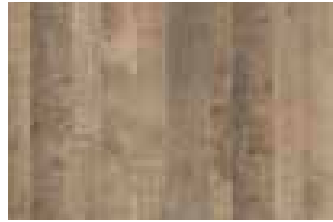

K356 PW
Sand Grange Oak



K087 PW
Dark Rockford Hickory

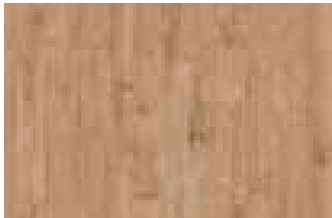

K361 PW
Gold Harbor Oak

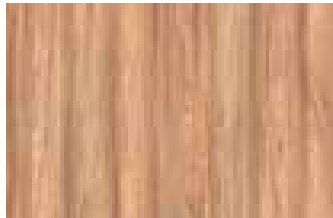

K021 SN
Barley Blackwood



K359 PW
Brandy Castello Oak

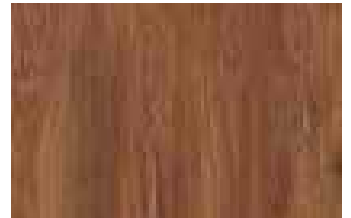

K545 RW
Vintage Silverjack Oak

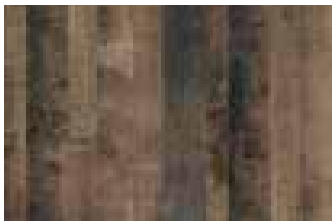

K354 PW
Colonial Grange Oak

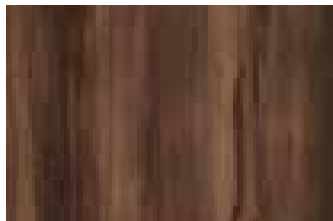

K537 RW
Ristretto Baroque Oak

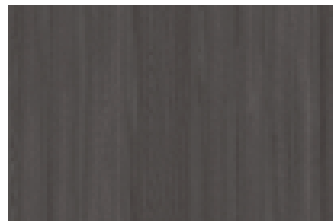

K526 SN
Iron Surfside Ash

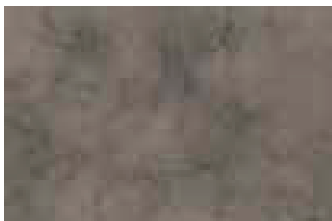

K539 PN
Fossil Arosa

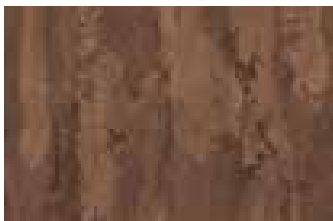

K351 RT
Rusty Flow

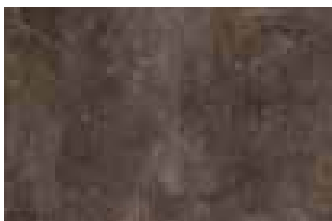

4299 SU
Dark Atelier

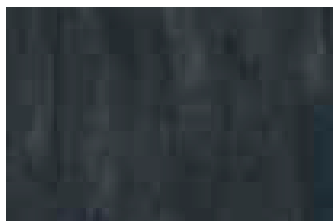

K353 RT
Charcoal Flow



The offer of Kronospan Standard

NEW



K010 SN
White Loft Pine



K001 PW
White Craft Oak



K088 PW
White Nordic Wood



K080 PW
White Coastland Oak

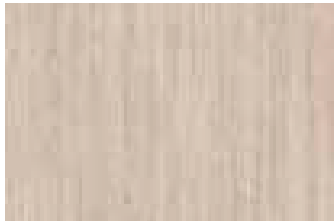

5529 SN
Oregon



K081 PW
Satin Coastland Oak



K002 PW
Grey Craft Oak



K005 PW
Oyster Urban Oak

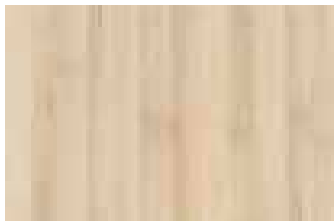

K012 SU
Pearl Artisan Beech



8921 BS
Ferrara Oak

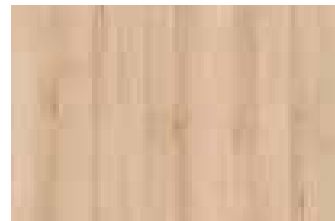

K013 SU
Sand Artisan Beech

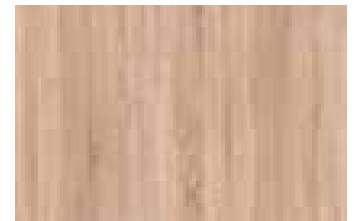

3025 SN
Light Sonoma Oak



1715 BS
Birch



0375 BS
Maple

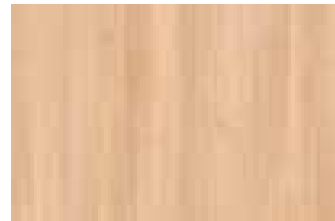

8431 SN
Nagano Oak

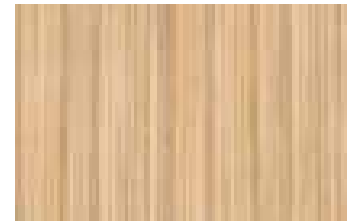

8995 SN
Coco Bolo

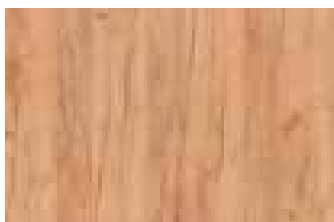

K003 PW
Gold Craft Oak

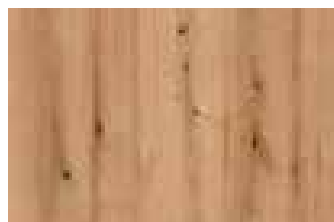

K365 PW
Coast Evoke Oak

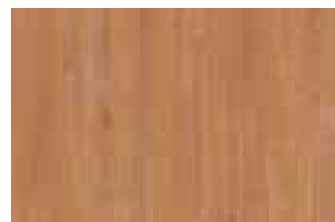

K078 PW
Dark Riverside Cherry

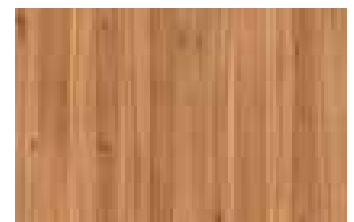

9614 BS
Light Lyon Walnut



K004 PW
Tobacco Craft Oak

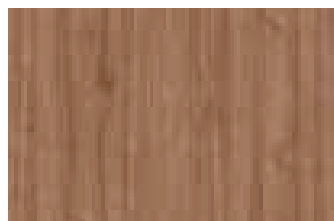

K009 PW
Dark Select Walnut

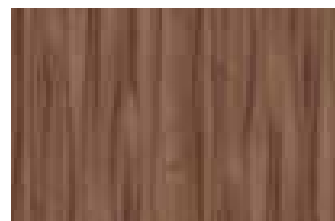

8953 SU
Tiepolo Walnut

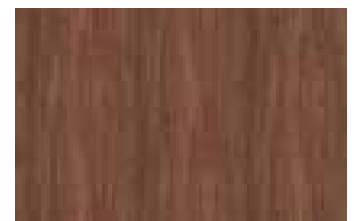

K015 PW
Vintage Marine Wood



K019 PW
Silver Liberty Elm



K079 PW
Grey Clubhouse Oak



K089 PW
Grey Nordic Wood



K366 PW
Fossil Evoke Oak



K017 PW
Blonde Liberty Elm



5194 SN
Oxide Vintage Oak

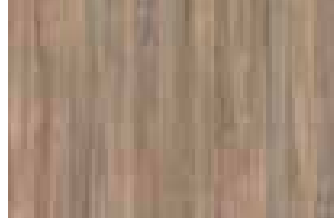

K018 PW
Smoked Liberty Elm

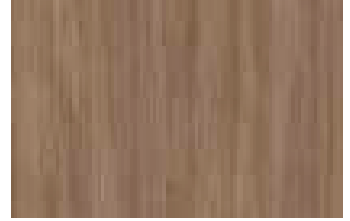

K007 PW
Coffee Urban Oak



K006 PW
Amber Urban Oak



K076 PW
Sand Expressive Oak

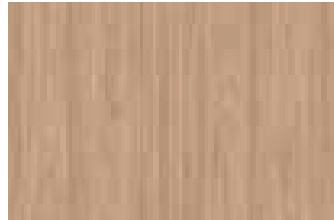

5500 SU
Natural Noble Elm

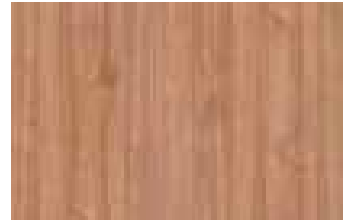

K008 PW
Light Select Walnut



0381 BS
Bavaria Beech



1912 BS
Alder



0344 BS
Cherry

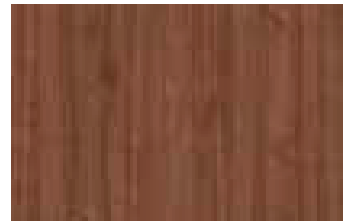

K020 PW
Fireside Select Walnut

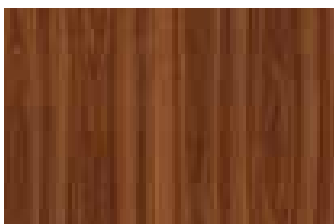

0729 BS
Walnut



K082 PW
Bourbon Oak



0854 BS
Wenge



9763 BS
Louisiana Wenge



K090 PW
Bronze Expressive Oak

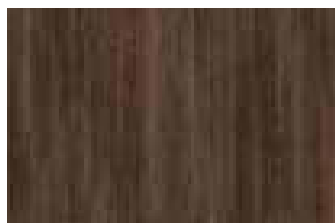

7648 SN
Vintage Wenge



8548 SN
Finesline Mocca



K016 PW
Carbon Marine Wood

The offer of Kronospan Color

NEW

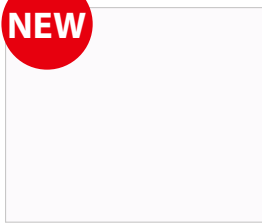

8681 SU
Brilliant White

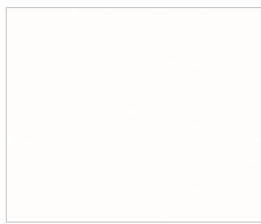

0110 SM
White

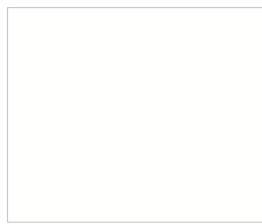

0101 PE
Front White

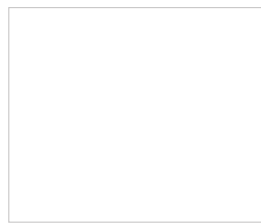

8685 BS
Snow White

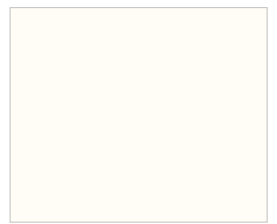

8100 SM
Pearl White

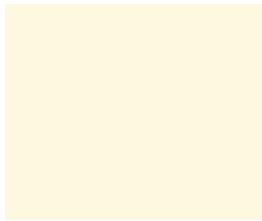

0564 PE
Almond



7045 SU
Satin



5981 BS
Cashmere



0540 PE
Manhattan Grey



0197 SU
Chinchilla Grey

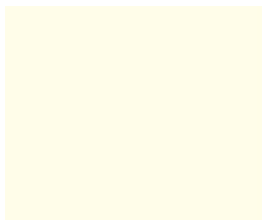

7031 BS
Crème

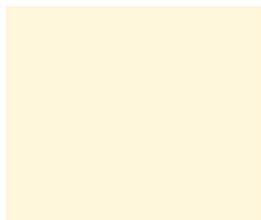

0514 PE
Ivory

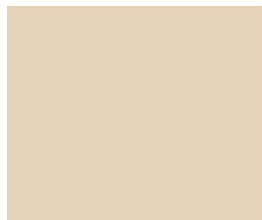

0522 PE
Beige

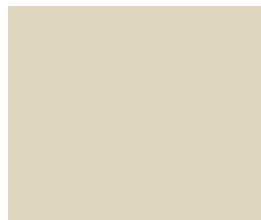

5982 BS
Mussel



0515 PE
Sand



0134 BS
Sunshine



K516 SU
Toffee



0132 BS
Orange



7113 BS
Chilli Red



K514 SU
Deep Sahara

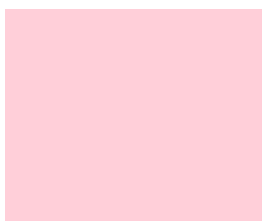

K513 SU
Marshmallow



K512 SU
Native Pink



K518 SU
Surf Blue



K517 SU
Azure Blue



0125 BS
Royal Blue



7063 SU
Pastel Green



K097 SU
Dusk Blue



7190 BS
Mamba Green



9561 BS
Oxide Green



K521 SU
Smoke Green

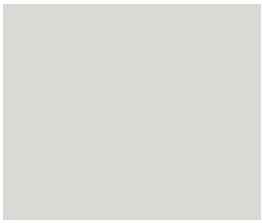

0191 SU
Cool Grey



0112 PE
Stone Grey



1700 PE
Steel Grey



K522 PE
Aluminium Flash



K523 PE
Platinum Disk



K519 SU
Mouse Grey



0171 PE
Slate Grey



0162 PE
Graphite Grey



0164 PE
Anthracite



0190 PE
Black

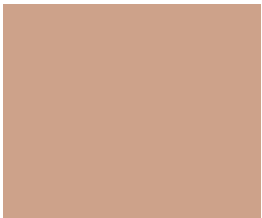

8533 BS
Macchiato



0301 SU
Cappuccino

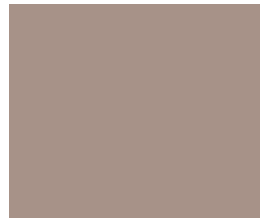

K096 SU
Clay Grey

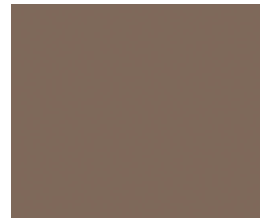

7166 BS
Latté

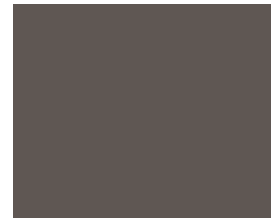

6299 BS
Cobalt Grey



K098 SU
Ceramic Red



9551 BS
Oxide Red



K515 SU
Spice Red



5994 SU
Alby Blue



8984 BS
Navy Blue

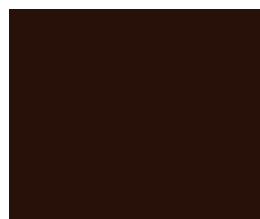

7181 BS
Dark Chocolate



0244 SU
Petrol



K520 SU
Dark Emerald



0166 BS
Basalt





Moving World Prague





FF Mulda



Magna Exteriors & Interiors



Star Fitness Mulhouse



Zoom Cycle Praha



Golfplatz Moossee



Grandhotel Hradec, Pec pod Sněžkou



APAG Elektronik s.r.o.



APAG Elektronik s.r.o.



Van Leeuwen



Magna Exteriors & Interiors



Library VŠE, Praha



3D Yoga Pardubice



Mergon Czech s.r.o.



Office building Vinice



Schule Eschlikon



Vyncke s.r.o.



Elementary School Pardubice - Polabiny, Npor. Eliáše



Förderschule Schönebeck



Hardcore Gym Aarau



Golf Resort Lipiny



Tongo, Hradec Králové



SPORTCENTRUM
IVANOVICE

Sportcentrum Ivanovice



Schrack Technik GmbH



Jarý s.r.o.







Fitness und Freizeitwelt Progress

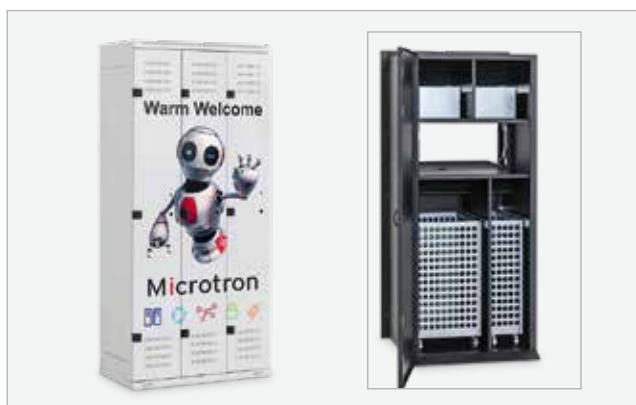



Marketing – Exhibitions

Tritón has been participating in exhibitions, starting with its first in 1995.

International fair FIBO

- Cologne 2011 - 2015

International fair for firefighters Interschutz

- Hannover 2010, 2015

International exhibition for firefighters Florian

- Karlsruhe 2013, Dresden 2014, 2016, 2018

International fair for living Mobitex

- Brno 2008 - 2010

In cooperation with our business partners our products were also presented at:

- **International fair for integrated emergency system Infopol** - Kortrijk 2015, 2017, 2019
- **Sport Achat** - Lyon 2019
- **Mountain Planet** - Grenobl 2018
- **ISPO** - Munich 2017
- **Health & Care** - Ghent 2016
- **SportsFair**- Fredericia 2016

- **FSB**- Cologne 2015
- **Suisse Public** - Bern 2013, 2015
- **Sport Achat** - Lyon 2015
- **Golf Europe** - Augsburg, 2012, 2013, 2014
- **Euro Attractions Show** - Paris 2013, Amsterdam 2014, Göteborg 2015
- **Green Expo** - Paris 2013
- **Golfshow** - 2011
- **Vienna tec** - Vienna 2012
- **GaLaBau** - Nuremberg 2016



The International Fitness Trade Fair FIBO 2012 - Essen, Germany



MOBITEX 2010 - International Trade Fair of Living – Brno



SUISSE PUBLIC 2013



SportsFair 2016



The International Fitness Trade Fair FIBO 2013 - Cologne, Germany



Presentation

Triton showroom

There is no better argument for a product than a demonstration of a sample. For this purpose, we have set up a presentation centre with samples of our products: clothes lockers, golf lockers, lockers for firefighters and rescue services, data cabinets and other products.





Packaging, transportation

Packaging

We deliver our products in special packaging. Clothes lockers have edges protected by highly resistant polyurethane foam and the whole locker is then protected with a shrinkwrap against dust and scratching when being transported. All our products are distributed on wooden pallets.

Transportation

Transportation of our goods is provided with our own vehicles or in cooperation with our contract carriers.



Certificates



ISO 9001:2015



ISO 14001:2015



ISO 45001:2018



Tritón Pardubice, spol. s r. o.

č.p. 130, 530 02 Starý Mateřov, Czech Republic

Tel.: +420 467 401 111

E-mail: info@satniskrinky.cz

Triton Chemnitz GmbH

Teichstraße 11, 09366 Niederdorf, Germany

Tel.: +49 (0) 37296 5498-0

E-Mail: info@garderobenspinde.de

www.clotheslockers.eu

